



US00D325378S

United States Patent [19]

[11] Patent Number: **Des. 325,378**

Ansell et al.

[45] Date of Patent: **** Apr. 14, 1992**

[54] **PERSONAL COMPUTER ENCLOSURE**

[76] Inventors: **Daniel F. Ansell**, 4100 NW. 107th Ave., Coral Springs, Fla. 33065; **Vincent S. Garmon**, 6829 Alden Ridge Dr., Boynton Beach, Fla. 33437; **Steven E. Howell**, 861 Edgewood Dr., Lexington, Ky. 40515; **Michael S. Miller**, 2520 Mallard Dr., Delray Beach, Fla. 33444

[**] Term: **14 Years**

[21] Appl. No.: **525,000**

[22] Filed: **May 18, 1990**

[52] U.S. Cl. **D14/100**

[58] Field of Search D14/100, 102, 104, 107, D14/108, 109; D13/184, 199; 360/97.01-99.12, 132, 133, 413; 361/380-385, 330-335, 390-395, 415, 426; 200/5 A, 5 R, 6 A, 6 R; 312/208, 201, 299

[56] **References Cited**

U.S. PATENT DOCUMENTS

- D. 279,675 7/1985 Akiyama D14/109 X
- D. 284,664 7/1986 Davis et al. D14/100

- D. 289,056 3/1987 Davis et al. D14/100
- D. 292,515 10/1987 Martin D14/100
- D. 293,443 12/1987 Davis et al. D14/100
- D. 293,444 12/1987 Garmon D14/100
- D. 293,675 1/1988 Yokoi et al. D14/100
- D. 293,910 1/1988 Alfonso et al. D14/100
- D. 294,577 3/1988 Kline D14/100
- D. 307,746 5/1990 Armstrong et al. D14/100
- D. 309,299 7/1990 Ott D14/109
- D. 311,903 11/1990 MacDonald D14/100

Primary Examiner—Susan J. Lucas
Assistant Examiner—Freda S. Nunn
Attorney, Agent, or Firm—Daniel E. McConnell

[57] **CLAIM**

The ornamental design for a personal computer enclosure, as shown and described.

DESCRIPTION

FIG. 1 is a left, top, front perspective view of the personal computer enclosure showing our new design; FIG. 2 is a left side elevational view thereof; FIG. 3 is a rear elevational view thereof; FIG. 4 is a right side elevational view thereof; FIG. 5 is a right, top, front perspective view thereof; FIG. 6 is a front elevational view thereof; and, FIG. 7 is a top plan view thereof. FIGS. 2-4 and 6 are drawn on an enlarged scale.

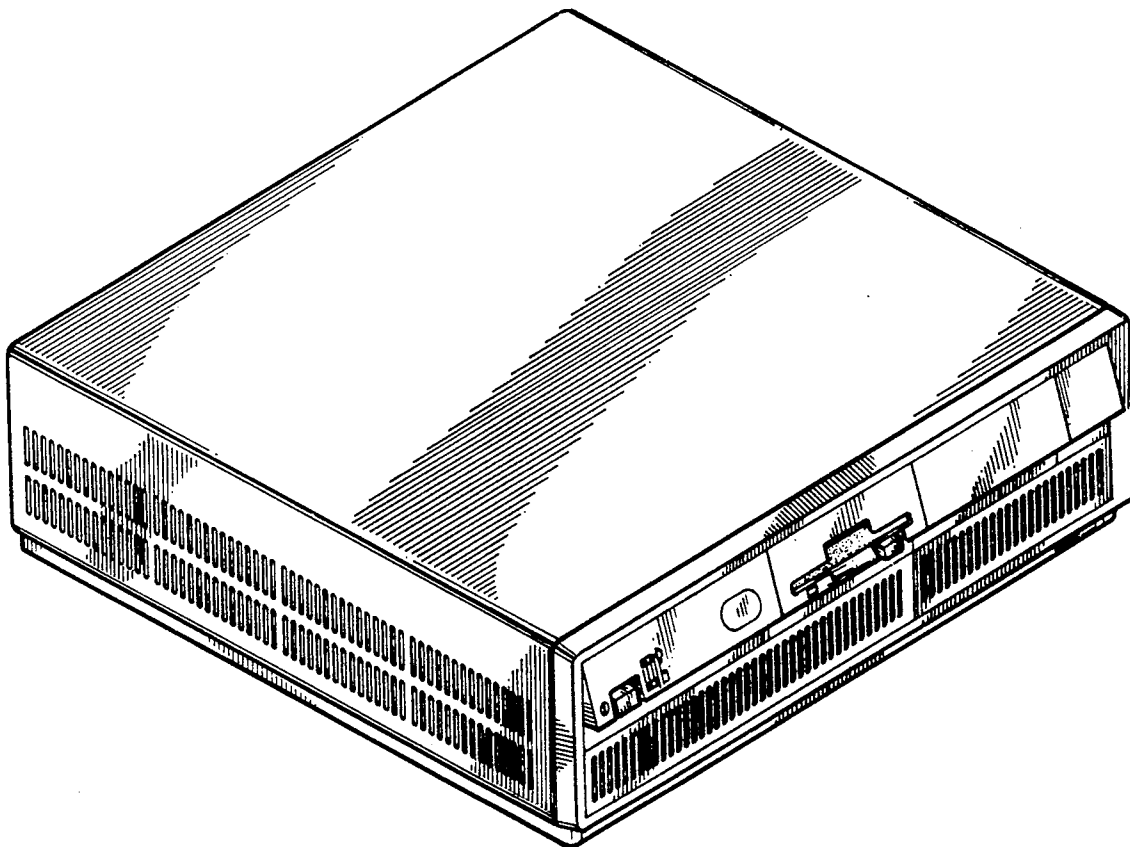

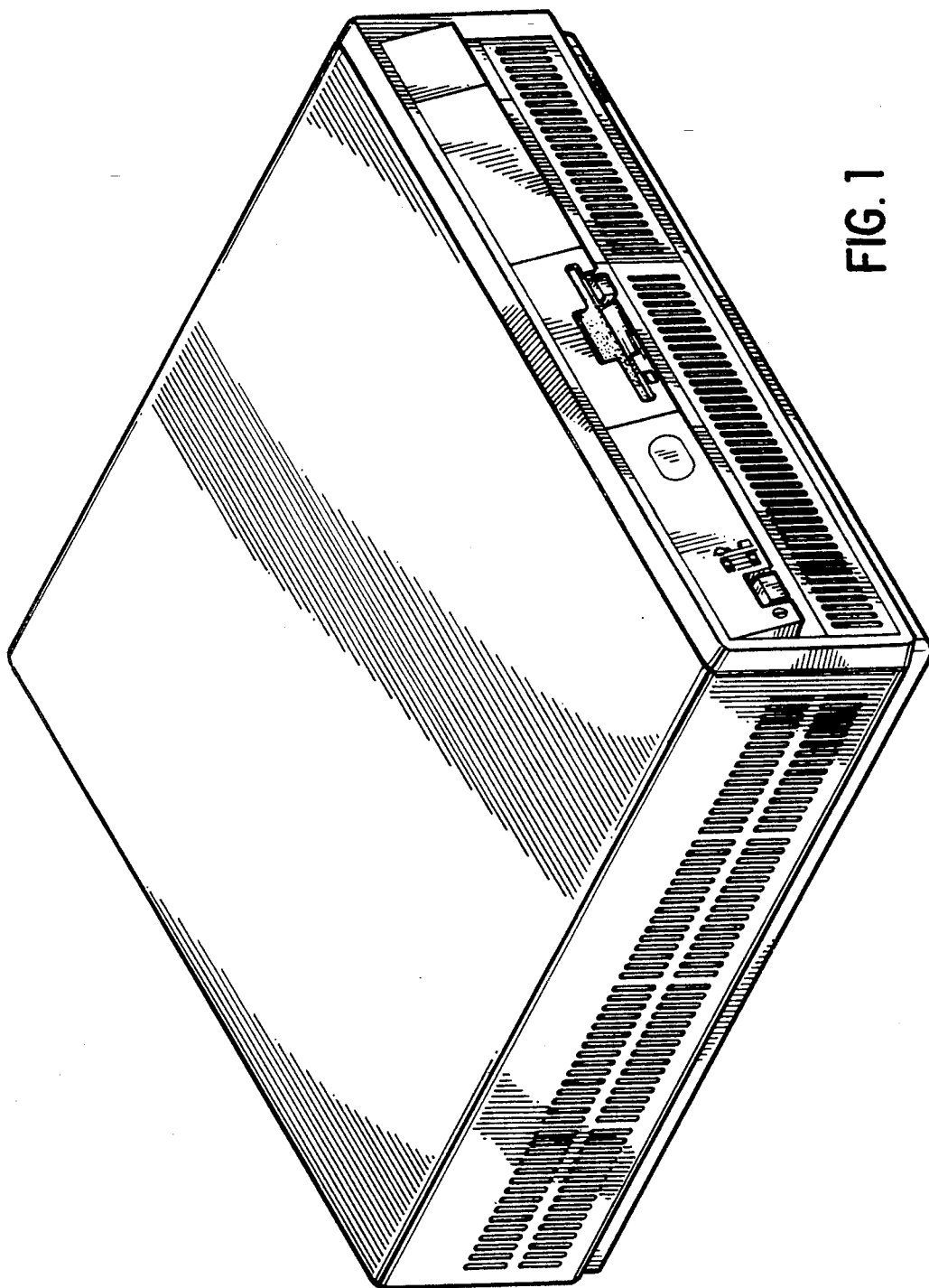

FIG. 1

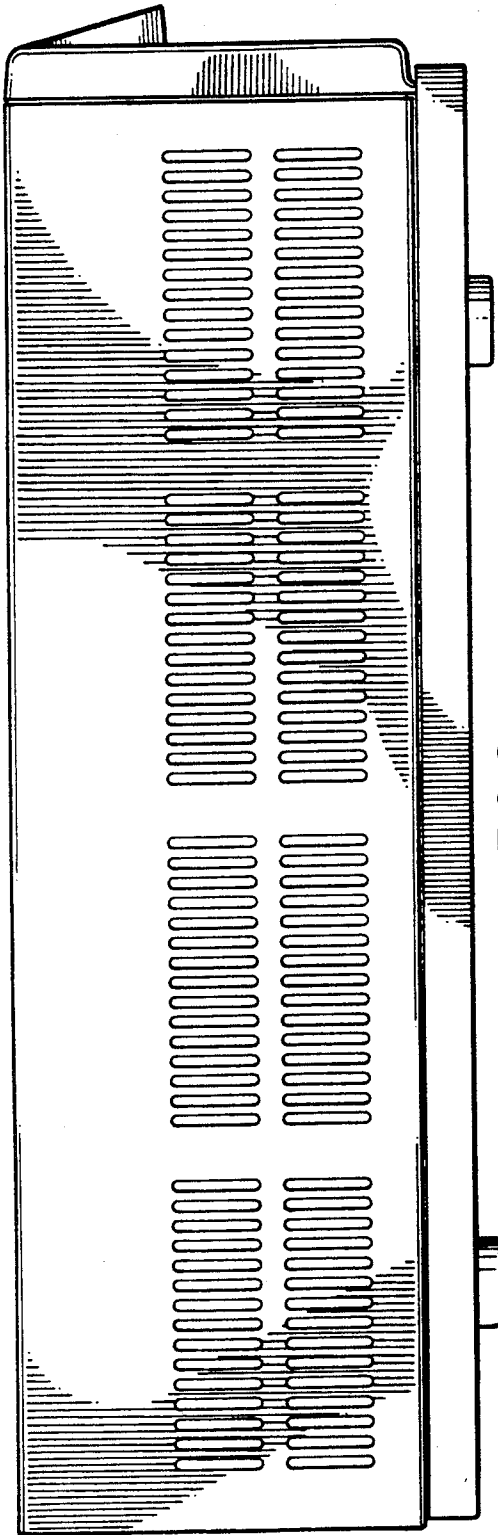

FIG. 2

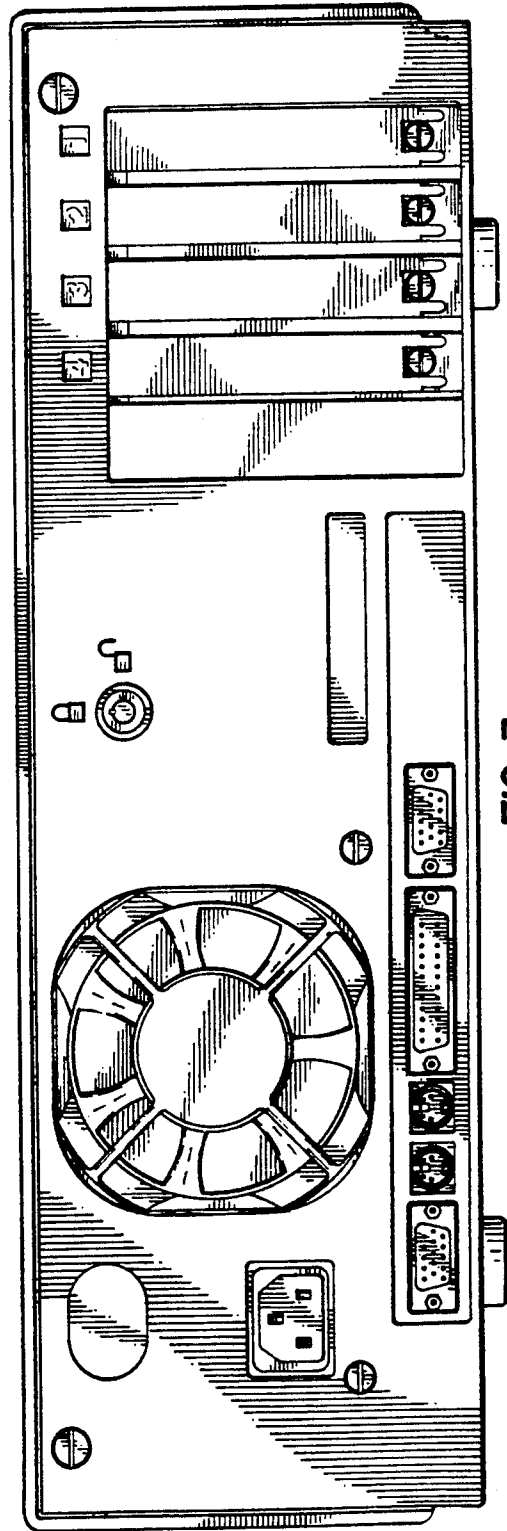

FIG. 3

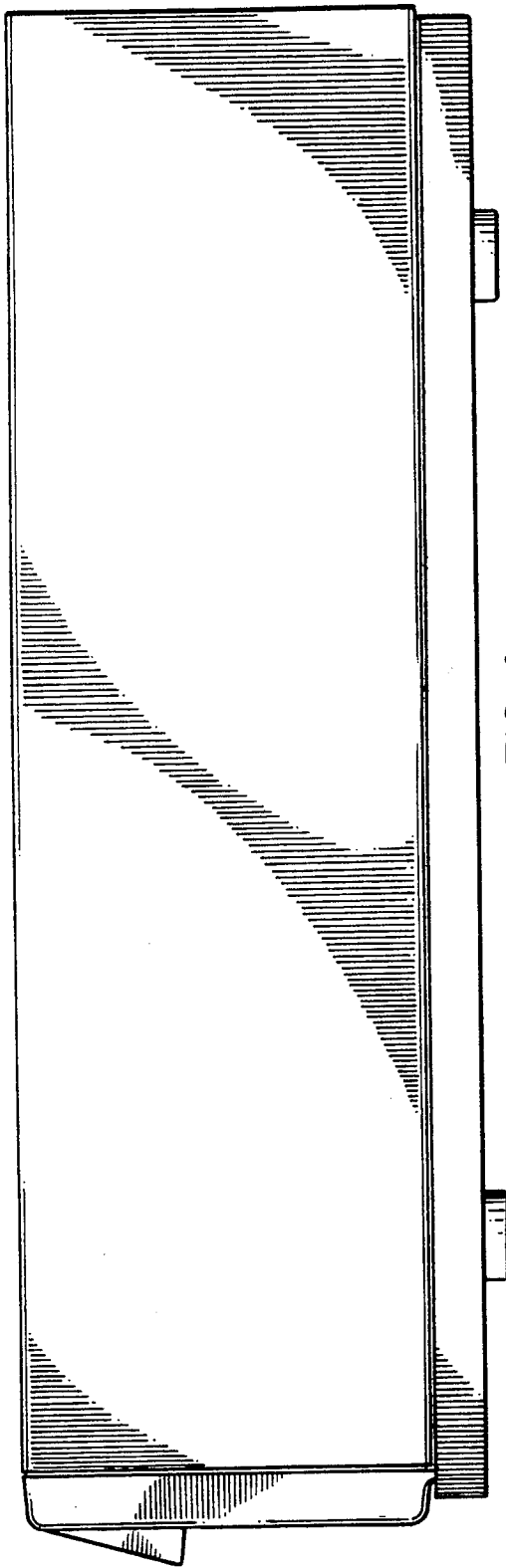

FIG. 4

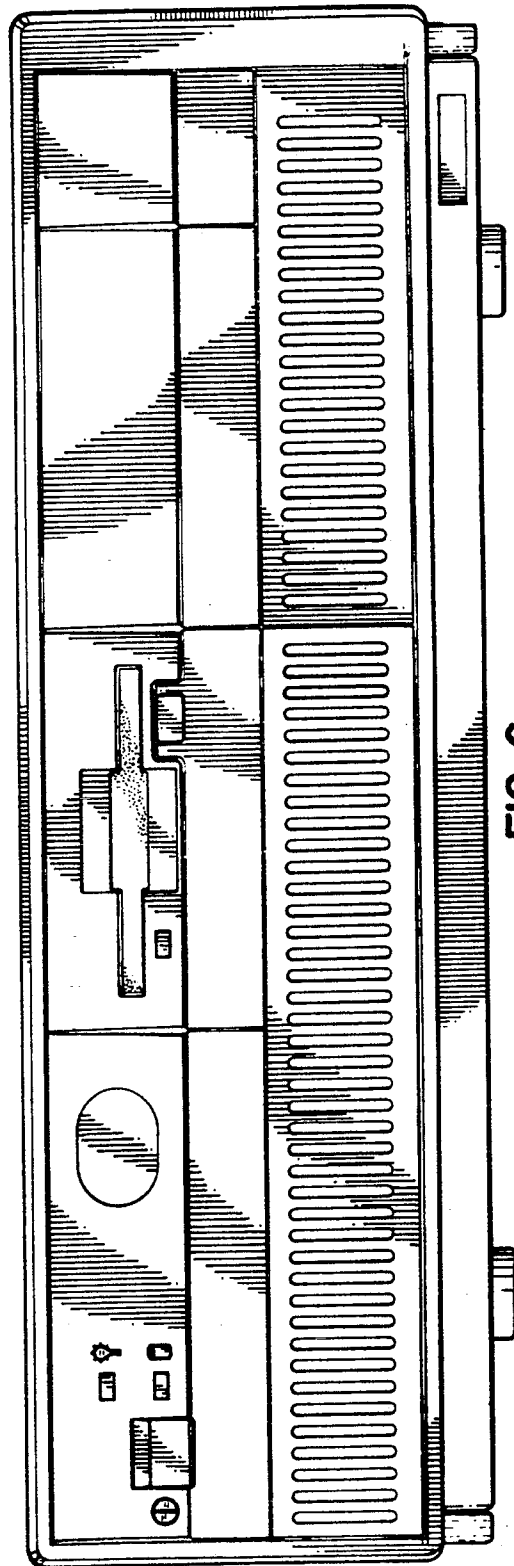

FIG. 6

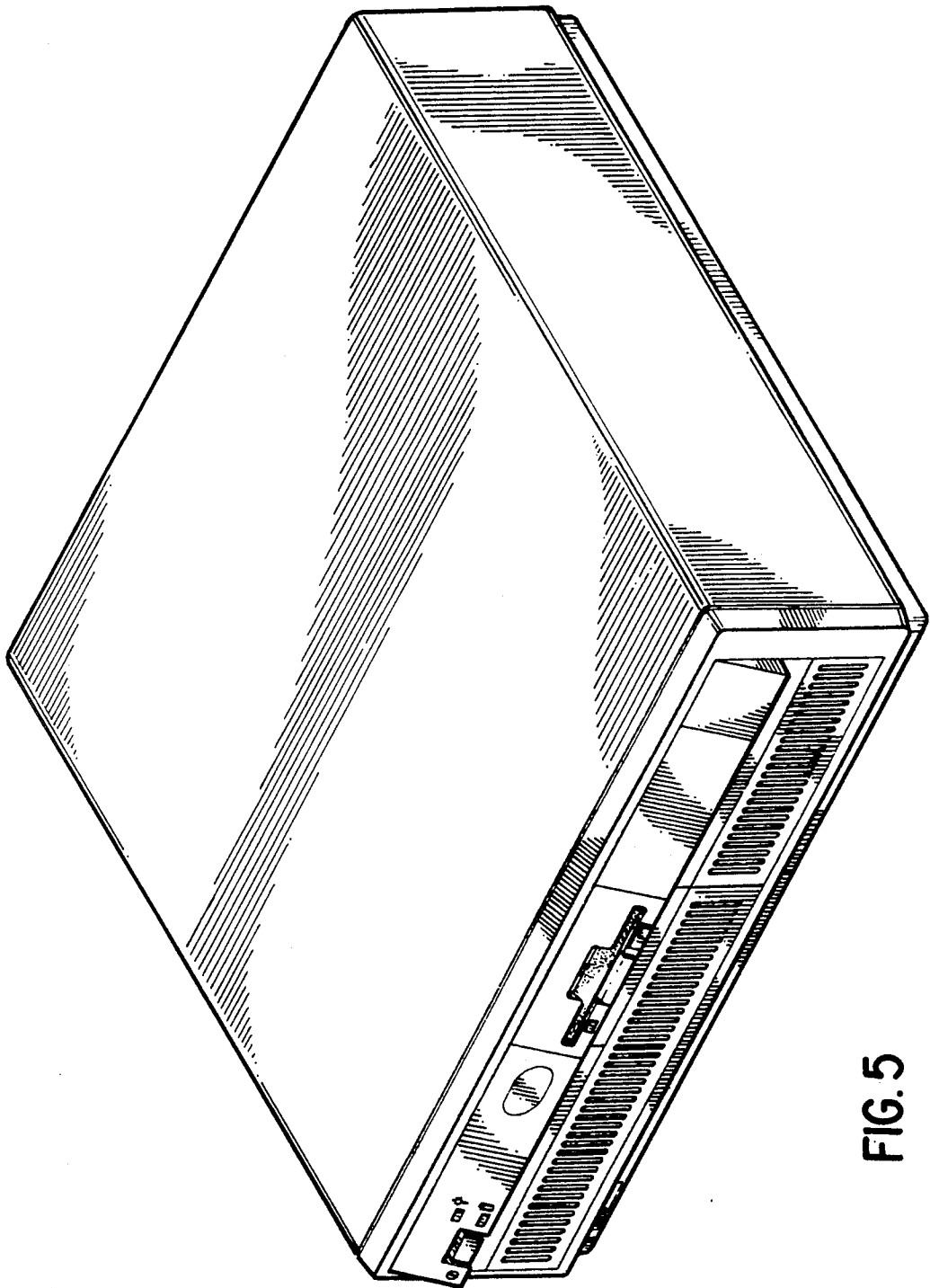

FIG. 5

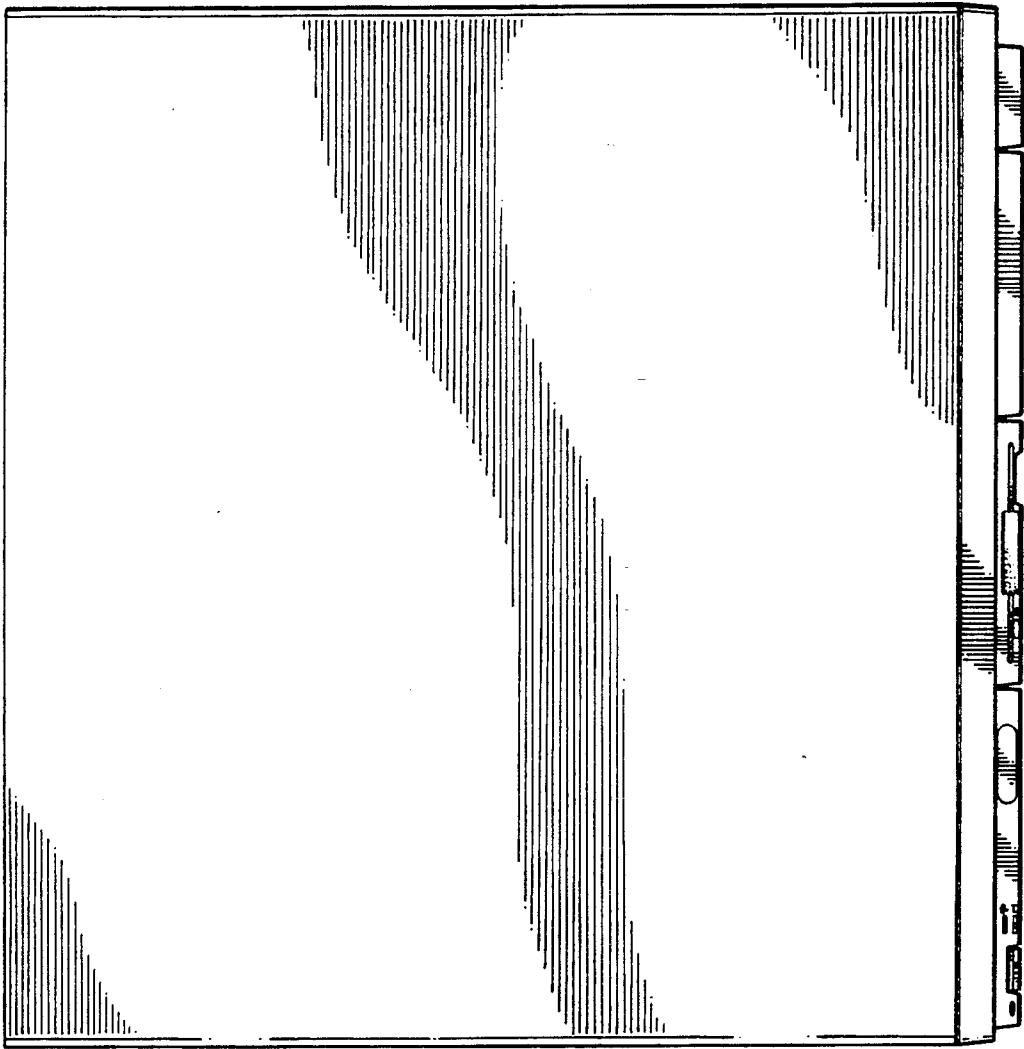

FIG. 7