



INTEGRATED DEVICE TECHNOLOGY



The Windows Microprocessor for Business Applications

More on IDT / Centaur: www.winchip.com

Reach Mike Bruzzone: campmktng@aol.com or 408/492-8637



INTEGRATED DEVICE TECHNOLOGY

Centaur Technology

Founded by Glenn Henry - 1995.

Former Vice President: MIPs Technology & Dell Computer.
Former IBM Fellow: Managed System 38 (AS 400) Development.

Funded by Integrated Device Technology (IDT).

Supplier of specialty SRAM.
Supplier of 32 & 64-bit MIPs microprocessor for workstation and embedded applications.
Expanding into x86 microprocessors.

Unique Design Approach (Simple RISC principles applied to x86 design).

x86 RISC Technical Expertise.

Microprocessor design experts from IBM, Motorola, TI, Dec.
System design experts from Dell, IBM Motorola, TI.
Wholly original and unique "ground up" x86 microprocessor design.

Headquarters, Austin Texas.

Design center
Compatibility and verification lab.



INTEGRATED DEVICE TECHNOLOGY

IDT Background

Founded	1980
Stock (IPO -1980)	NASDAQ: IDTI
Employees	4,400
Products	350
SRAM, FIFO, Logic, SMP, ATM, RISC & x86 Microprocessors	
Product Configurations	> 5,000
Revenues (CY 1996)	\$ 554,000,000
Major Design Wins	SGI Workstations (MIPs) Cisco Routers (MIPs) Web TV (MIPs) Evergreen MX Pro Upgrade (x86)

IDT Quality Focus

1995/96	Malcolm Baldrige (Self Assessment)
1994	STACK 0001 ISO 9002 - Penang ISO 9001 - SSD
1993	ISO 9001 / 9002 - San Jose, Salinas, Santa Clara
1990	Corporate Quality Mission Statement
1989	DESC Audit
1980	Military 883 Supplier



INTEGRATED DEVICE TECHNOLOGY

Manufacturing Facilities

Corporate Headquarters:

Santa Clara, California

Semiconductor Fabrication Facilities:

Salinas, California

San Jose, California

Hillsboro, Oregon

NOW

SOON

Assembly & Test Facilities:

Penang, Malaysia

Manila, Philippines

IDT CAN BUILD IT!

San Jose

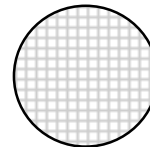

6"

Hillsboro

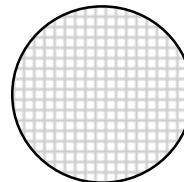

8"

IDT WinChip Fabs



20,000 6" Wafers / qtr
0.5 / 0.3 Micron Process
Built 1990





50,000 8" Wafers / qtr
0.5 / 0.2 Micron Process
Built - 1995



INTEGRATED DEVICE TECHNOLOGY

What is the IDT WinChip C6 Microprocessor?

- Unique & original x86 processor manufactured & sold by IDT, designed and marketed by Centaur Technology, a wholly owned subsidiary of IDT.
- Microsoft Windows 95  tested compatible by Microsoft, XXCAL Platinum  Certified.
- Optimized for Windows business applications; tuned for memory & integer performance.
- Equal features with Pentium MMX, AMD K6 MMX, Cyrix 6x86 MX: on-chip FPU & MMX.
- Comparable WinStone 97 business performance: to Pentium MMX, K6 MMX, 6x86 MX.
- Very low power dissipation for portable applications: <10 watts at 200 MHz at 3.3 volts.
- Socket 7 compliant: 296 pin CPGA, broad motherboard availability, commodity pricing.
- Works with ALI, VIA, SIS, Intel and other chip sets.
- Works with Award, AMI, Phoenix and SystemSoft BIOS.
- Targets superior price / performance for sub \$1,000 PCs & sub \$2,000 notebooks.



INTEGRATED DEVICE TECHNOLOGY

IDT WinChip C6 Compatibility - OS & Network Partial List

Operating System

Windows 3.1x

Windows 95

Windows 98*

Windows NT 4.0

Windows NT 5.0*

MS DOS 6.22

Novell DOS 7.0

SCO Open Unix 5.0

Linux

Designed for

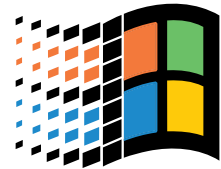

Microsoft®
Windows® 95



Network Environment

Windows NT 4.0 Server

Banyon Vines 7.0

OS/2 Warp Server

Novell Netware 3.12

Novell 4.11

* Based on reports from user group members who are beta testers.

IDT WinChip C6 is fully compatible with over 60,000 x86 native operating systems, network environments & software applications.

See www.winchip.com for hardware and software compatibility lists.



INTEGRATED DEVICE TECHNOLOGY

WinChip Family Road Map to Higher Performance



- > 300 MHz.
- 64 KB L1 cache.
- 256 KB L2 cache.
- 0.25 micron process.
- 2.5v core, 3.3v I/O.



- 64KB L1 cache.
- 6% better Winstone 97 Vs. C6.
- 2x better FPU performance Vs C6.
- 2x better MMX performance Vs. C6.
- Works with AGP chipset boards.
- New x86 instructions supporting Microsoft Direct 3D graphics acceleration.
- 2.5v core, 3.3v I/O.
- 0.35 / 0.26 micron process.

C6L2 >300 MHz Core
100 MHz CPU Bus

C6+ 300 MHz Core
100, 75, 66 MHz CPU Bus

C6+ 225/250/266 MHz Core
83.8, 75, 66 MHz CPU Bus

C6 240 MHz Core
60 MHz CPU Bus

C6 225 MHz Core
75 MHz CPU Bus

C6 200 MHz Core
66 MHz CPU Bus

C6 180 MHz Core
60 MHz CPU Bus

Sampling

MSRP



Ideal for Intel chip set boards limited to 66 MHz CPU bus speed.

\$135



Ideal for ALI, SIS & VIA chip set boards with up to 83.8 MHz CPU bus speed.

Shipping



\$89

- 64KB L1 cache.
- IEEE 80-bit floating point unit.
- MMX unit.
- Works with AGP chipset boards.
- 0.35 micron / 4 layer metal.

\$79

- Single voltage core & I/O.
- 3.3 or 3.52 volt power settings.

Distribution

Hamilton-Hallmark	800/778-2668
Wyle	800/582-Wyle
MA LABs	408/941-0808
Wintek	510/770-9239

Now

1st Half 1998

2nd Half 1998



INTEGRATED DEVICE TECHNOLOGY

Where to buy IDT WinChip - Local Reseller

Distribution for Hundreds of Units:

Hamilton - Hallmark: 800 / 778-2668

Wyle 510 / 582-WYLE

Distribution for Single Unit Quantities:

MA Labs: 408 / 941-0808 ext 148

Wintek: 510 / 770-9239 ext 496

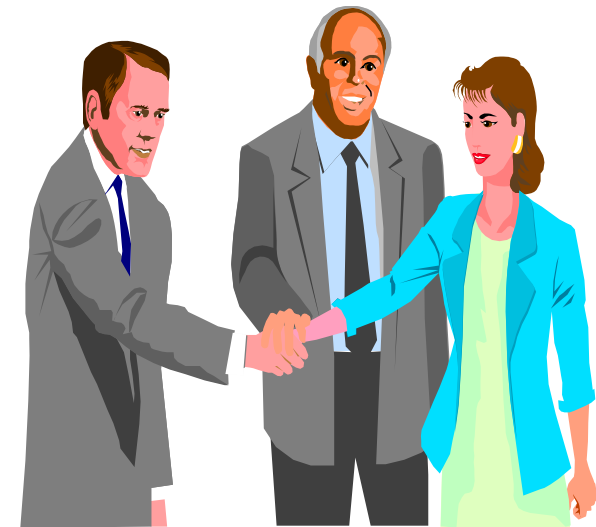

See www.winchip.com.

ASK YOUR LOCAL PC INTEGRATOR OR COMPUTER RESLLER.

If they don't have it . . . ask for it . . . order from MA LABS or Wintek for prompt delivery.



INTEGRATED DEVICE TECHNOLOGY

Why is the IDT WinChip C6 Optimized for Windows?

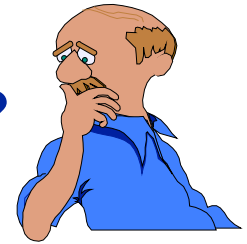

Windows applications:



- Windows is the pervasive operating system. Optimizing for Windows makes sense.

Low cost and reallocation of the processor budget:

- State-of-the-art PCs are growing less costly as manufacturers experiment with cost streamlined motherboards including higher levels of component integration. The objective is to streamline bill of materials so sub \$1,000 retail price targets can be met enabling access by a growing market. Optimizing the CPU for low cost parallels B.O.M. requirements and keeps percent of total budget allocated to the CPU relative to other semiconductor components.
- Amazingly, these cost streamlined PCs offer great performance with all the features customers want for current and a new generation of performance Windows software.

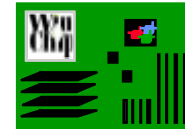

Low power and reallocation of the power budget:



- Mobile computing is also on the rise. So, optimizing for low power also makes sense. Low power processors allow reallocation of power budget to other peripherals: larger screens, CDROM, and PCMCIA cards including wireless communications.



Why is the IDT WinChip Optimized for Windows?

Windows Vs. CPU intensive applications:

Windows applications are memory bandwidth limited, involve random, non-algorithmic sequences of instructions which scatter across PC memory subsystems.

Because data required by Windows applications can scatter across PC memory subsystems, it's important to capture the most needed data and instructions on chip close to CPU execution units. [WinChip](#) includes 64 KB of L1 on-chip cache memory, twice that of Pentium with MMX, for this purpose. In addition, L1 cache management and coherency techniques are employed to reduce unnecessary CPU system bus traffic between the CPU, L2, main memory and storage. This keeps WinChip processing, and off the slower system bus, which promotes sustained performance levels from a scalar CPU. The ability to sustain performance by avoiding CPU stall given delay from bus access can offset any advantage that might be achieved from a superscalar CPU capable of multiple instructions in any one clock. If a superscalar CPU by its very design is required to access the slower system bus more often, performance can in fact be less.

Programs exhibiting random instructions are best matched to a scalar processor because there is little opportunity to execute instructions in parallel. In many cases, [IDT WinChip C6'](#) single fast pipeline can execute code as fast as one or more complex pipelines in a superscalar processor like [Intel Pentium MMX](#), [AMD K6 MMX](#) and [Cyrix 6x86 MX](#).

In addition, synthetic CPU benchmarks like Intel ICOMP, Spec, Norton SI and Landmark tend to focus on repetitive, unrealistic algorithms compared to a Windows environment. In relation to application benchmarks, CPU benchmarks primarily exercise execution units, do not reflect real world applications, and are in most cases designed using code optimized for parallel execution. These benchmarks can overstate Windows application's performance for a superscalar processor because they are made with the available adders to execute instructions in parallel.



Why is the IDT WinChip C6 Optimized for Windows?

Focus on memory performance:

- Large L1 on-chip memory caches, 32 KB of data and 32 KB of instruction, allow room for the most frequently used data and instructions to reside on chip, reducing the potential for CPU access to slower L2, main memory and storage subsystems.
- No pre-decode bits are used in the instruction cache maximizing physical cache size for actual instructions.
- Large 64 entry TLBs (Translation Look-Aside Buffers); index that keeps track of memory page faults optimizing performance of L1 cache to reduce CPU access time to slower memory.
- Byte Accumulation; byte merging is a feature of the IDT WinChip C6 which enables a reduction in the number of accesses to main memory. The processor detects when code is writing within the same 8-byte address range as the previous write, and if so, it combines the two writes into one write on the bus further reducing CPU access time to slower memory.
- Coherent Cached LOCK-ed Cycles; other Socket 7 processors mandate that all locked memory accesses (E.G XCHG w/memory) not be cached. This implies that the associated cache lines cannot be brought into the caches if they were not already there, and if they were already in the L1 of L2 cache, they must be invalidated or cast out. Through cache management optimizations, IDT WinChip permits LOCK'ed accesses to be satisfied within the cache and without the possibility of the LOCK being broken further reducing CPU access time to slower memory.
- 8 Entry page Directory; protect-mode operating systems waste a significant amount of the processor's compute time translating the virtual address that the program specifies into a physical address to access system memory. This wasted time is incurred when an address is used which does not have a cached virtual to physical translation in the TLB. When a translation is not available, translation tables must be traversed to get the appropriate translation. The traversal is composed of a Page Directory table access and a page table access. IDT WinChip has a Page Directory Entry Cache which typically eliminates the need for a page directory access to slower memory.



INTEGRATED DEVICE TECHNOLOGY

How is the IDT WinChip C6 Optimized for Windows?

Focus on simple high speed scalar core:

- Simplicity in design yields faster cycle times in a given technology.
- IDT WinChip C6 delivers optimal performance for Windows instruction sequences which by their very nature rarely execute in parallel/

Superscalar (as opposed to scalar) implies the ability of a processor to process more than one instruction per clock (as opposed to just one instruction per clock). This is a noble goal, but in practice, real world code does not lend itself well to parallel execution because instructions are typically dependent on preceding instructions.

E.G. MOV EAX, 40
 ADD EAX, 10
 OR EAX, 1

In the above example, it can be seen that the EAX register is used in each instruction, and each instruction modifies the previous instruction's EAX, so for the program to operate correctly, the instructions must be executed serially as in a scalar processor. This dependency is unavoidable.

This poses a significant problem to the superscalar processor, in that they have to figure out on the fly whether instructions are dependent, and if so, they need to execute in a scalar fashion. Not only is this wasteful of hardware, it is typically less efficient than if they were always operating in a scalar fashion because of lack of optimization.



INTEGRATED DEVICE TECHNOLOGY

How is the IDT WinChip C6 Optimized for Windows?

So what does all this technical hocus pocus really mean:

Under the Windows 95 operating system, WinChip handles on-chip memory and CPU system bus traffic more efficiently than Pentium MMX, AMD K6 MMX and Cyrix 6x86 MX.

As Windows code rarely executes in parallel, a scalar Vs. superscalar design approach is optimal. Optimal in terms of processing efficiency, elimination of unnecessary logic that grows die size, processor cost and power gain without a proportional increase in actual Windows processing performance.

“IDT / Centaur used its transistor budget for bigger caches and TLBs instead of a complex CPU core. This trade-off reduces the amount of time the chip spends waiting for the bus while extending the time required for the CPU to complete some calculations. The net effect is roughly equivalent performance . . . “ - *Michael Slatter, Microprocessor Report*

IDT WinChip = Windows Optimized Performance & Super Value.



INTEGRATED DEVICE TECHNOLOGY

IDT WinChip C6 Key Technical Features & Benefits

Simple RISC Scalar Core

Simple RISC core can easily be scaled (manufactured) to achieve higher clock speeds Vs. more complex superscalar designs like **Pentium MMX**, **AMD K6 MMX** and **Cyrix 6x86 MX**.

C6 RISC results in smallest die @ 88 mm² and lowest power for 0.35 micron.

Die size optimized - scalar design and hardware maximized to sustain core processing at one (1) instruction per clock cycle Vs. potential to achieve multiple instructions per clock cycle from a superscalar design.

32 KB Writeback Level 1 Data Cache

2x the size of **Pentium MMX** with 16 KB I-cache. Optimized to keep data on the chip running at core CPU speed and off the slower PC system bus.

Standard 296 Pin CPGA

Pentium compatible pin-out.

Fits (white) Socket 7 plug-in. Broadest available board design. Broad support means best price. C6 = 3.3 or 3.52v = easy upgrade.

Socket 7 boards now available with chip sets supporting AGP (Advanced Graphics Port) and CPU bus speeds up to 83.3 MHz. Look for ALI Aladdin V, SIS 5591, 5592 or VIA VP3. Super TX chipsets without AGP supporting higher than 66 MHz CPU system bus speed include ALI Aladdin IV, IV+, SIS 5571, 5582, 5597, VIA VPX and VP2.

Socket 7 with 100 MHz CPU system bus available Q2, 1998.

32 KB Writeback Level 1 Instruction Cache

2x the size of **Pentium MMX** with 16 KB D-cache. Optimized to keep data on the chip running at core CPU speed and off the slower PC system bus.

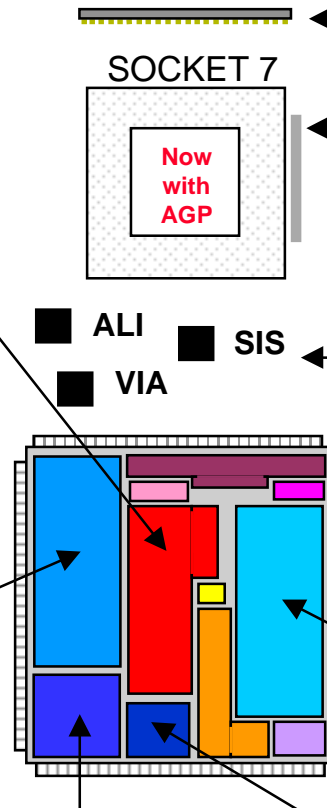

IEEE 754 80-bit Floating Point Unit **MMX Unit**

Equivalent features w/other CPUs. IEEE Compliant FPU for accuracy. **MMX** enabled for Windows Software.



IDT WinChip C6 Architecture - simple, scalar, RISC design tuned for high clock frequency and ease of manufacturing.

Simple 6 Stage Pipeline

- I Instruction
- X x86 to RISC Translate
- D Decode
- A Address
- E Execute
- W Writeback

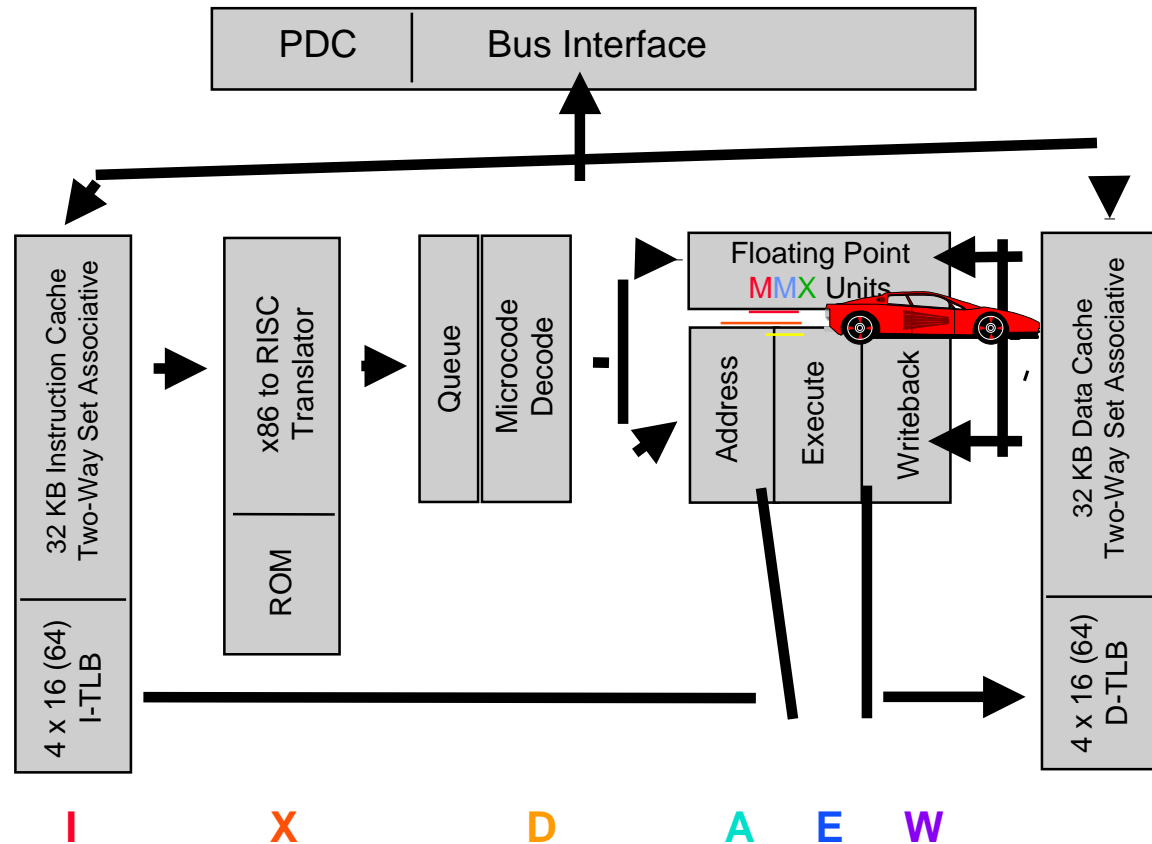

Scalar design optimized for sustained throughput @ 1 instruction per clock.

Reduced complexity for ease of debug, compatibility verification, cool running, easily scaled to higher clock speeds.



INTEGRATED DEVICE TECHNOLOGY

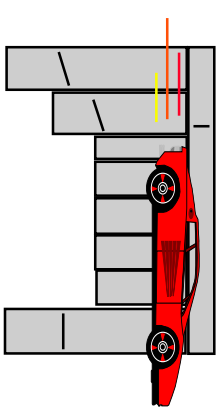

AMD K6 MMX

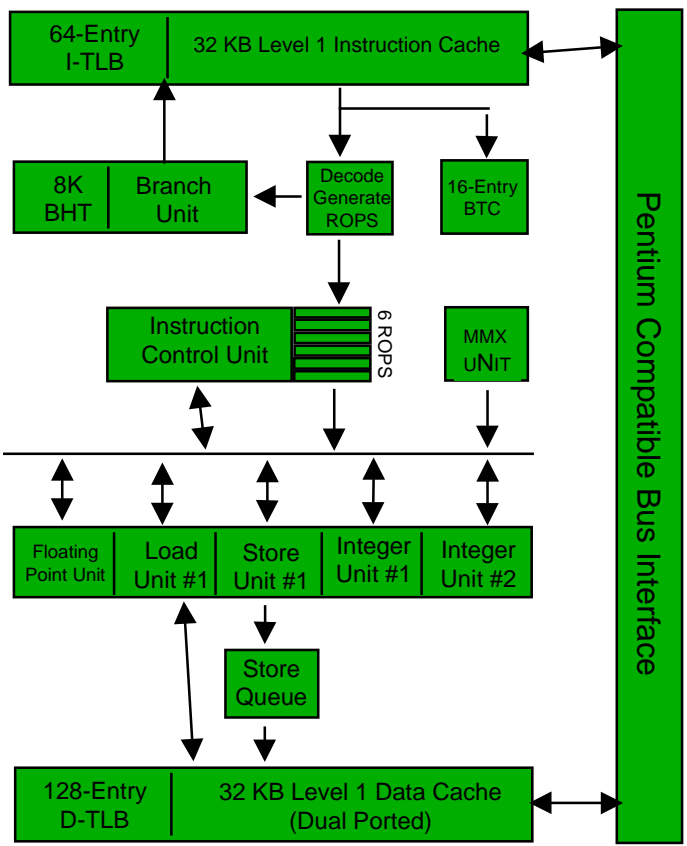

CYRIX 6x86 MX

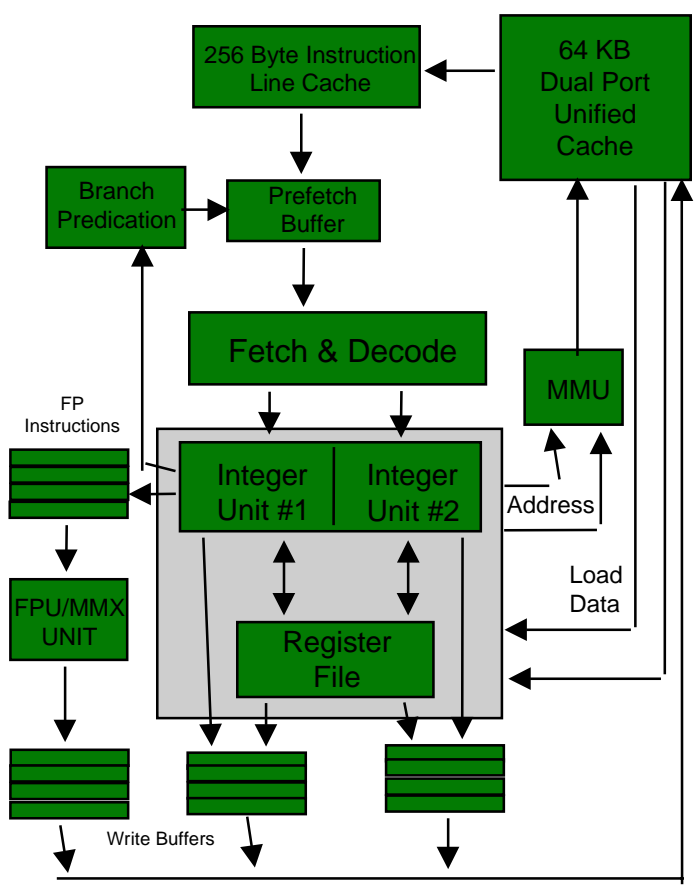

Compared to IDT WinChip C6, AMD K6 & Cyrix 6x86 are more complicated designs, run hotter, are harder to debug and can be tougher to make.



INTEGRATED DEVICE TECHNOLOGY

INTEL PENTIUM with MMX

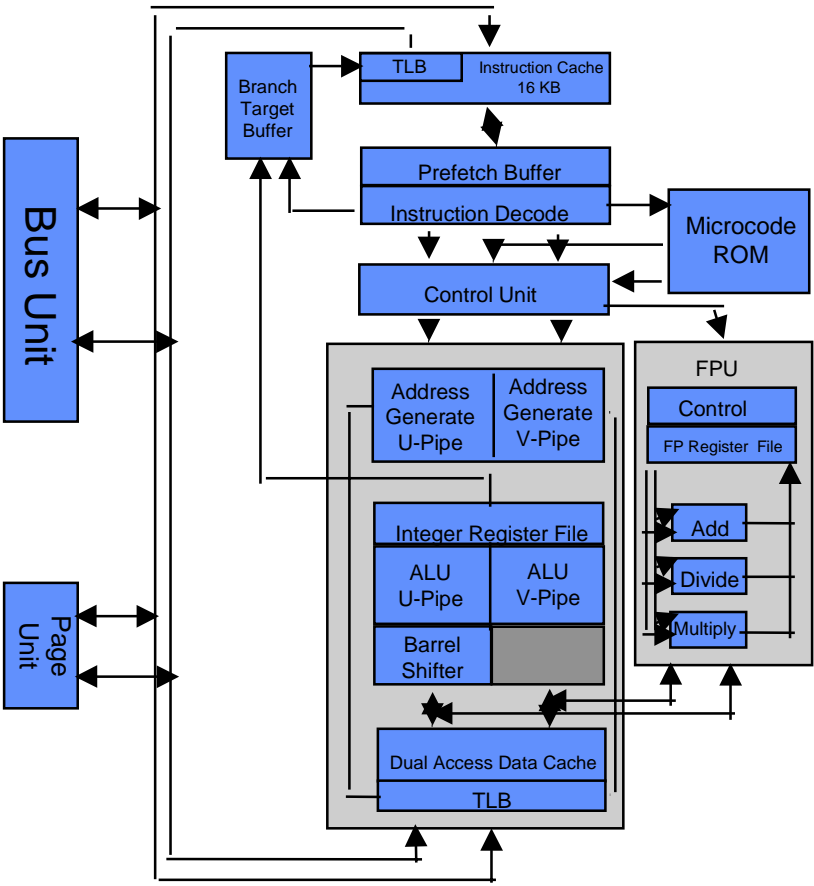

IDT WinChip C6 = Simple design for a competitive performer.

INTEL PENTIUM II

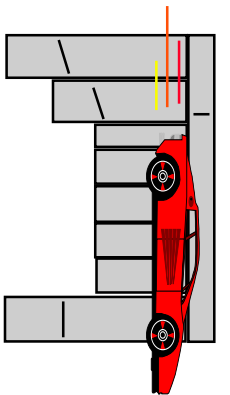
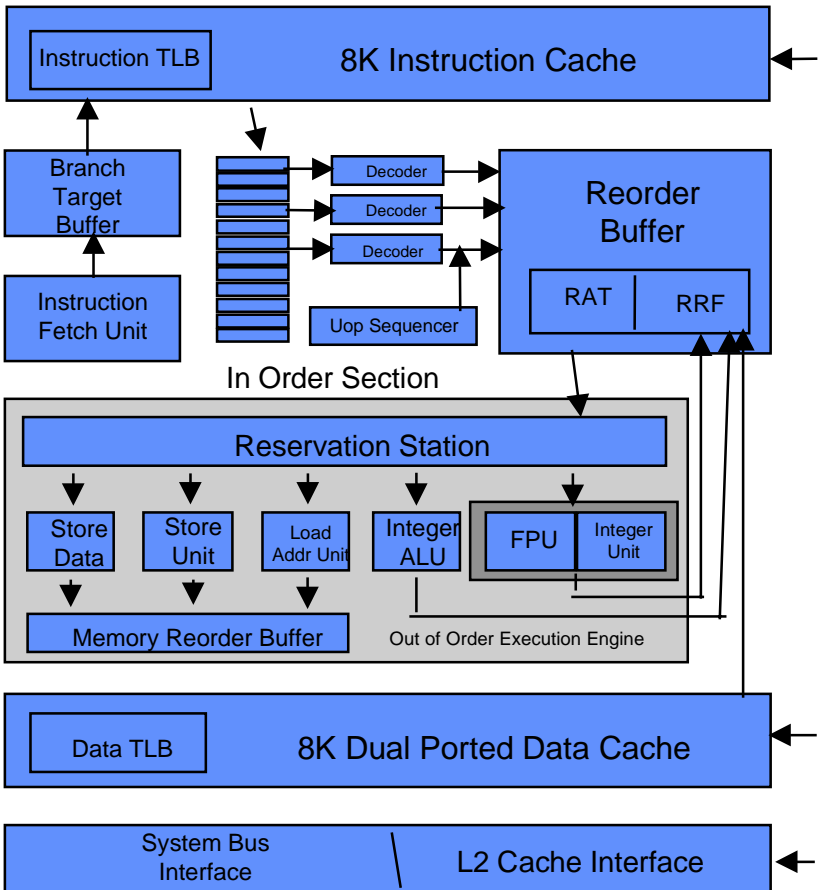



INTEGRATED DEVICE TECHNOLOGY

WinChip C6 Features, Benefit, Performance - Die Size @ .35 Micron

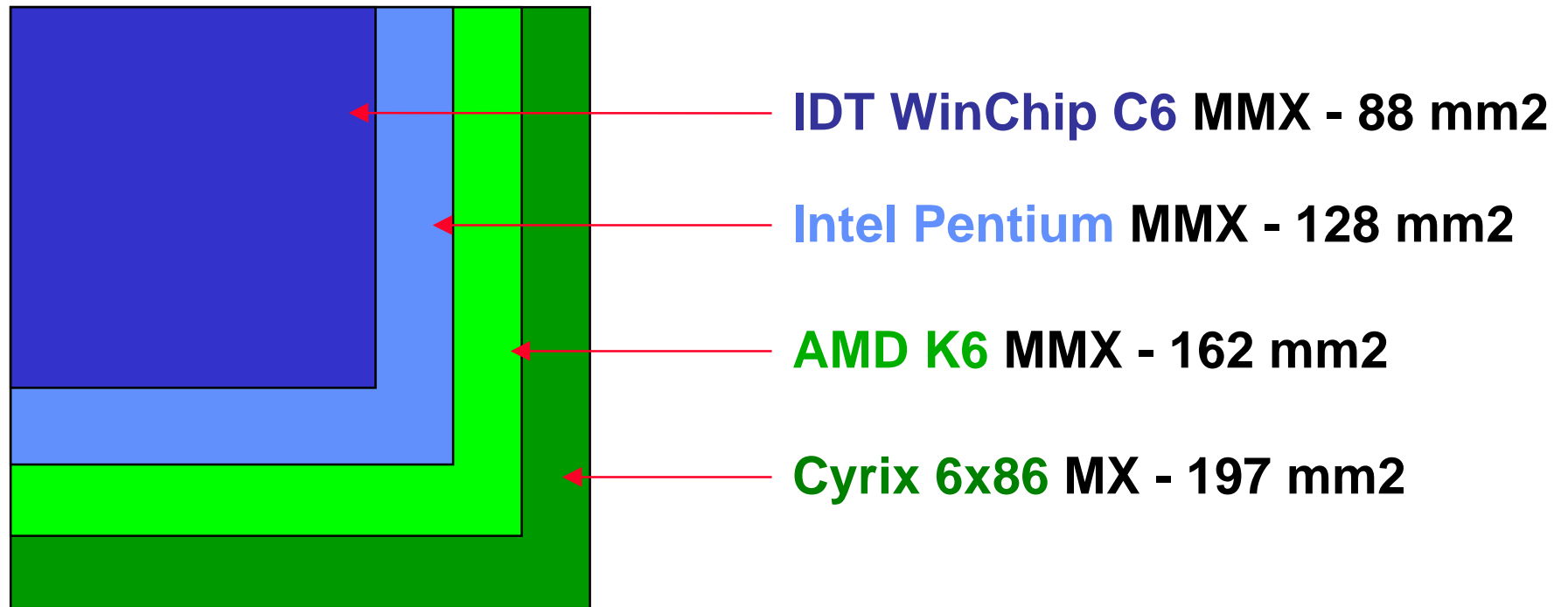

Smallest Die - Lowest Power - Low Heat - Low Manufacturing Cost



INTEGRATED DEVICE TECHNOLOGY

IDT WinChip C6 maximum power dissipation is lower than other 0.35 micron processors.

“C6 is an excellent choice for low power notebooks”
Microprocessor Report, 6/23/97

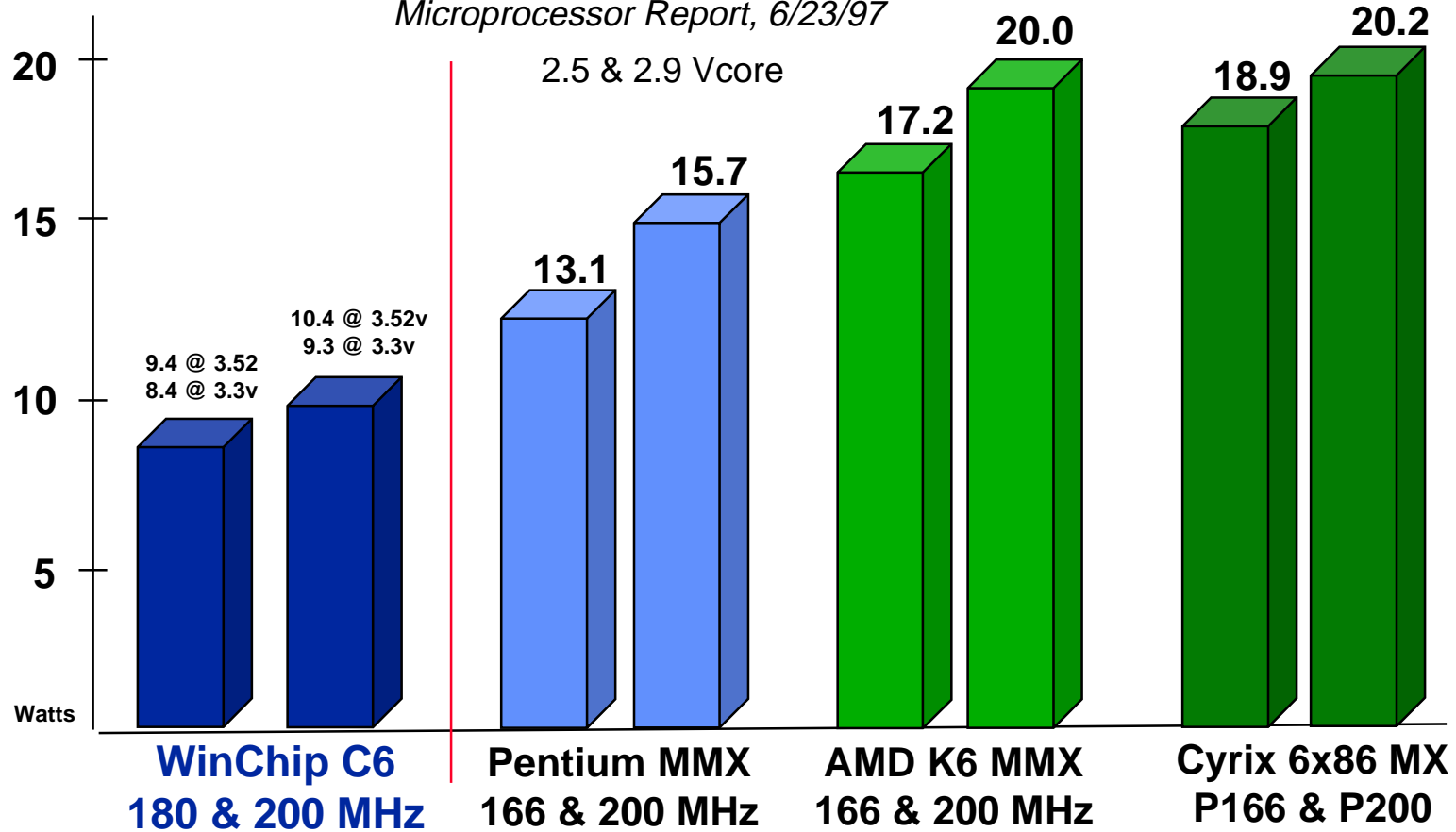

WinChip won't melt your motherboard.



INTEGRATED DEVICE TECHNOLOGY

IDT WinChip C6 offers comparable WinStone 97 business performance in a \$760 system hardware configuration.

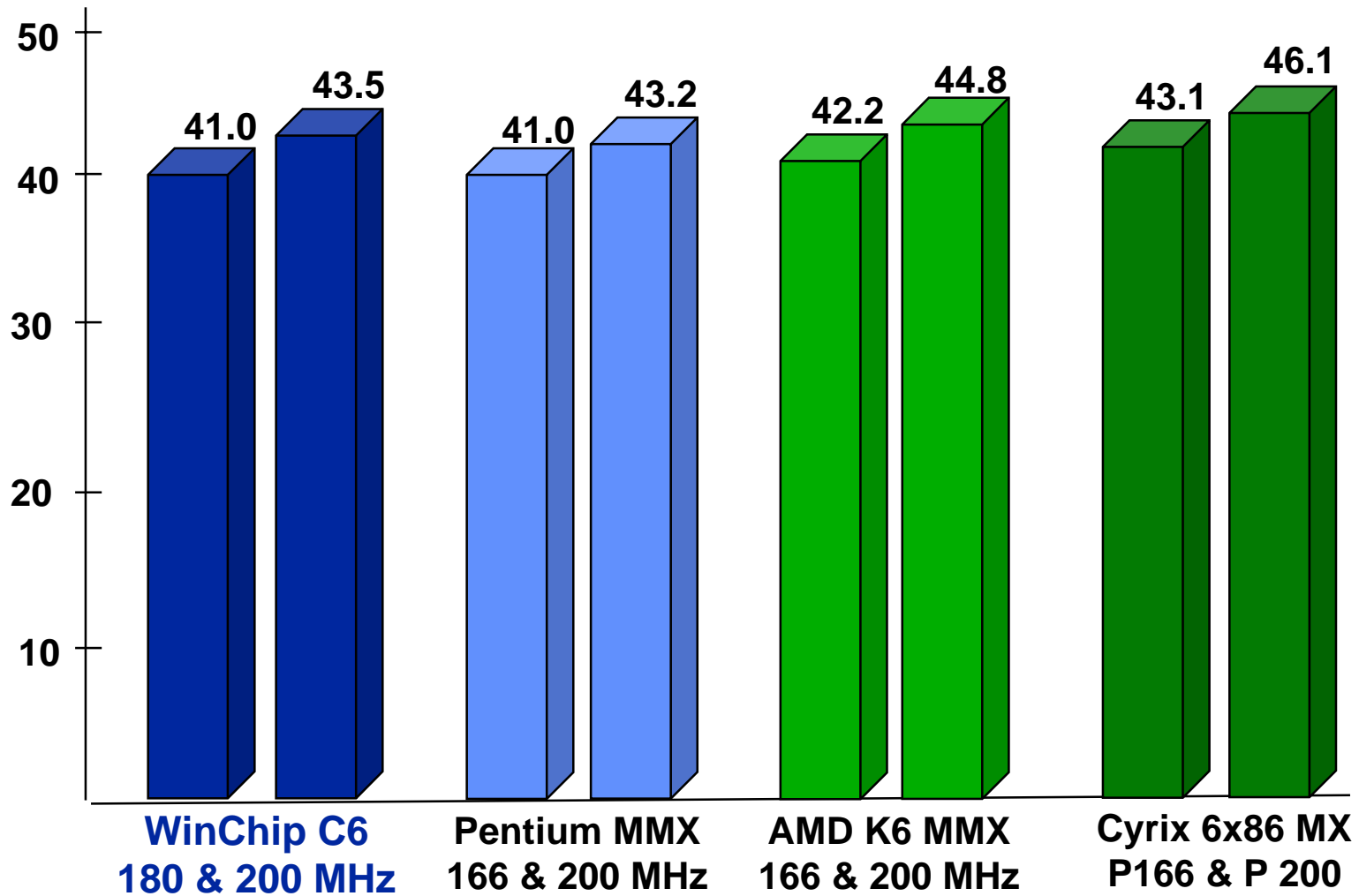



INTEGRATED DEVICE TECHNOLOGY

IDT WinChip C6 Vs. IDT WinChip C6+ Application / Use

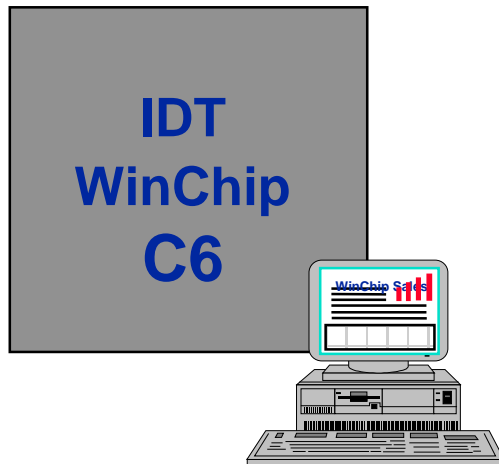

- Equivalent WinStone 97 business performance compared to **Pentium with MMX**, **AMD K6 MMX**, Cyrix 6x86 MX.
- Optimized for integer intensive Windows business applications in sub \$1,000 personal computers: word processing, spreadsheet, data base, 2d presentation, multimedia and edutainment.
- Includes FPU and MMX, but not intended for FPU intensive applications or use as a commercial workstation.

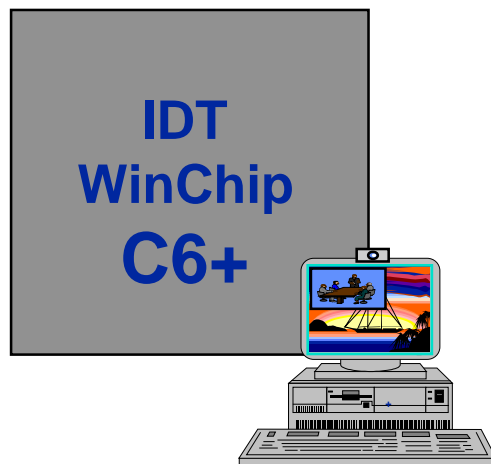

- 6% better WinStone 97 performance compared to IDT WinChip C6.
- 2x WinChip C6 floating point performance.
- 2x WinChip C6 MMX performance.
- New instructions supporting Microsoft 3D graphics performance.
- Superior overall performance compared to **Pentium with MMX**, **AMD K6 MMX**, **Cyrix 6x86 MX**.



IDT WinChip C6 Performance - Winstone 97 Business Application Suite.

Performance in a \$760 system hardware configuration.*

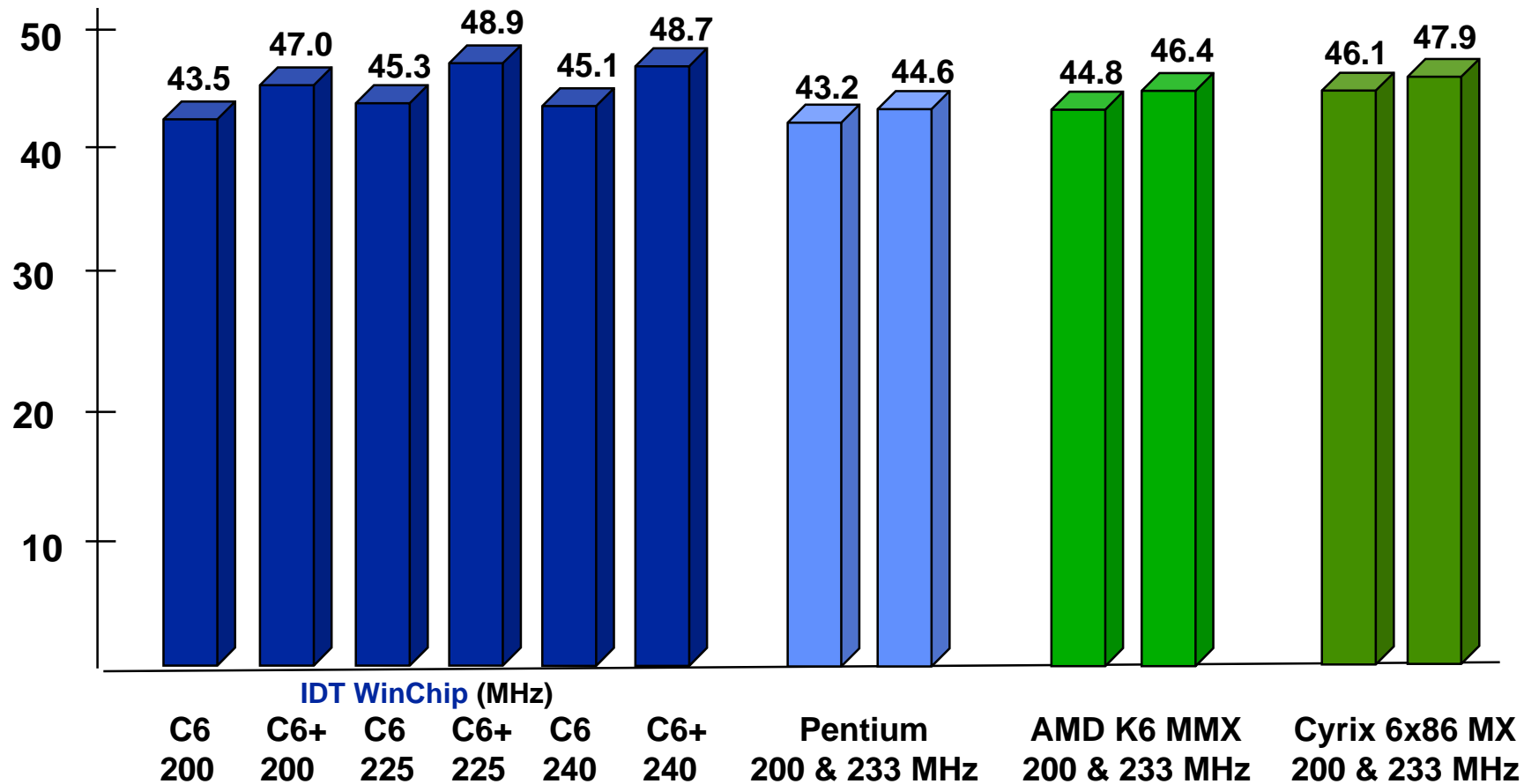

** Less CPU cost, assembly, Win 95 license. C6+ performance estimates.*



How are Socket 7 & Intel Slot 1 motherboards different?

Socket 7 - Open PC Standard

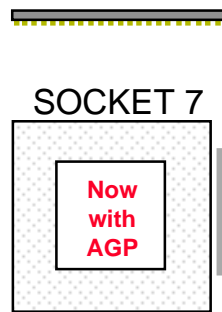

- Established design.
- Broadly available.
- Lowest cost.
- > 80% of PC shipments.
- 66, 75 & 83.8 MHz CPU bus.
- L2 cache up to 83.8 MHz.
- PCI to 33 MHz & higher*.
- ECC & SDRAM support, Ultra DMA 33 & AGP

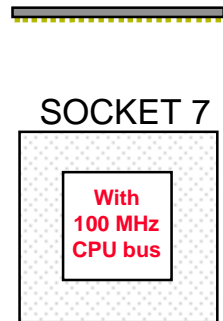

- Design enhancement.
- Extension of Socket 7.
- Highest performance.
- Available Q2 1998.
- Up to 100 MHz CPU bus.
- L2 cache up to 100 MHz.
- PCI to 33 MHz & higher*.
- AGP to 66 MHz & IEEE 1394 (Firewire)

Intel Slot 1 - Proprietary



- Intel only design.
- Single source supplier.
- High performance & costly.
- <20% of PC shipments.
- 66 MHz CPU bus only.
- 1/2 speed CPU bus to 150 MHz.
- PCI up to 33 MHz only.
- ECC & SDRAM support, Ultra DMA 33, AGP.

* ALI, SIS & VIA chip sets support asynchronous PCI which allows the CPU's system bus to run at 66, 75, up to 83.8 MHz, while maintaining PCI within its specified rating of 33 MHz. This assures stable peripheral bus timing. Some motherboards using ALI, SIS and VIA chip sets can be set to run PCI dividing the CPU system bus speed by 2, thus achieving a PCI speed exceeding the maximum rated specification of 33 MHz . . . At 37.5 or 41.75 MHz respectively. Note, instability can result across a mix of peripherals when PCI is run out of spec and warranties may be voided.



INTEGRATED DEVICE TECHNOLOGY

Support Socket 7 - Open Platform - Multiple Suppliers

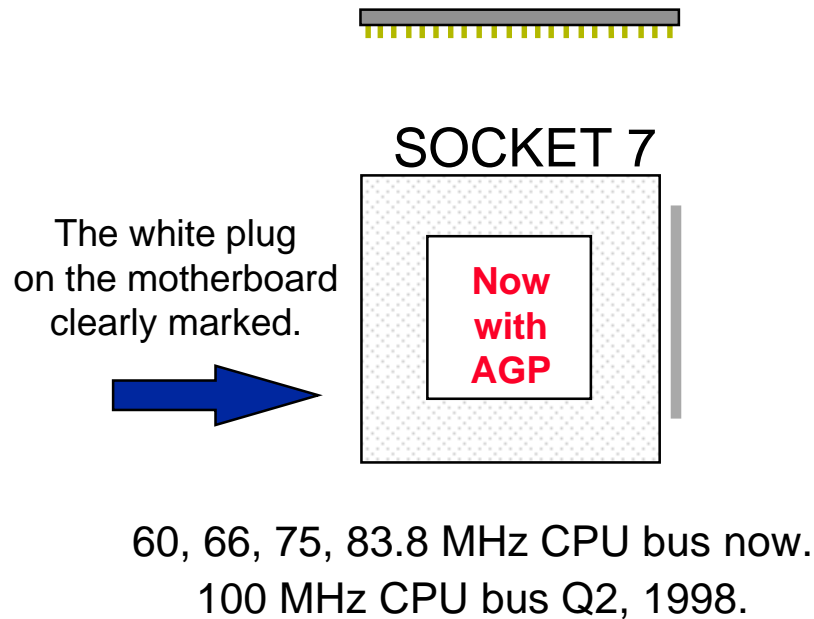

- ALI
- SIS
- VIA

**Market Driven
Price Performers.**

INTEL SLOT 1



**Extends the
Intel Captive Market.**



INTEGRATED DEVICE TECHNOLOGY

System price points are approximate for trending & discussion - Intel products are speculative - Do your own research.

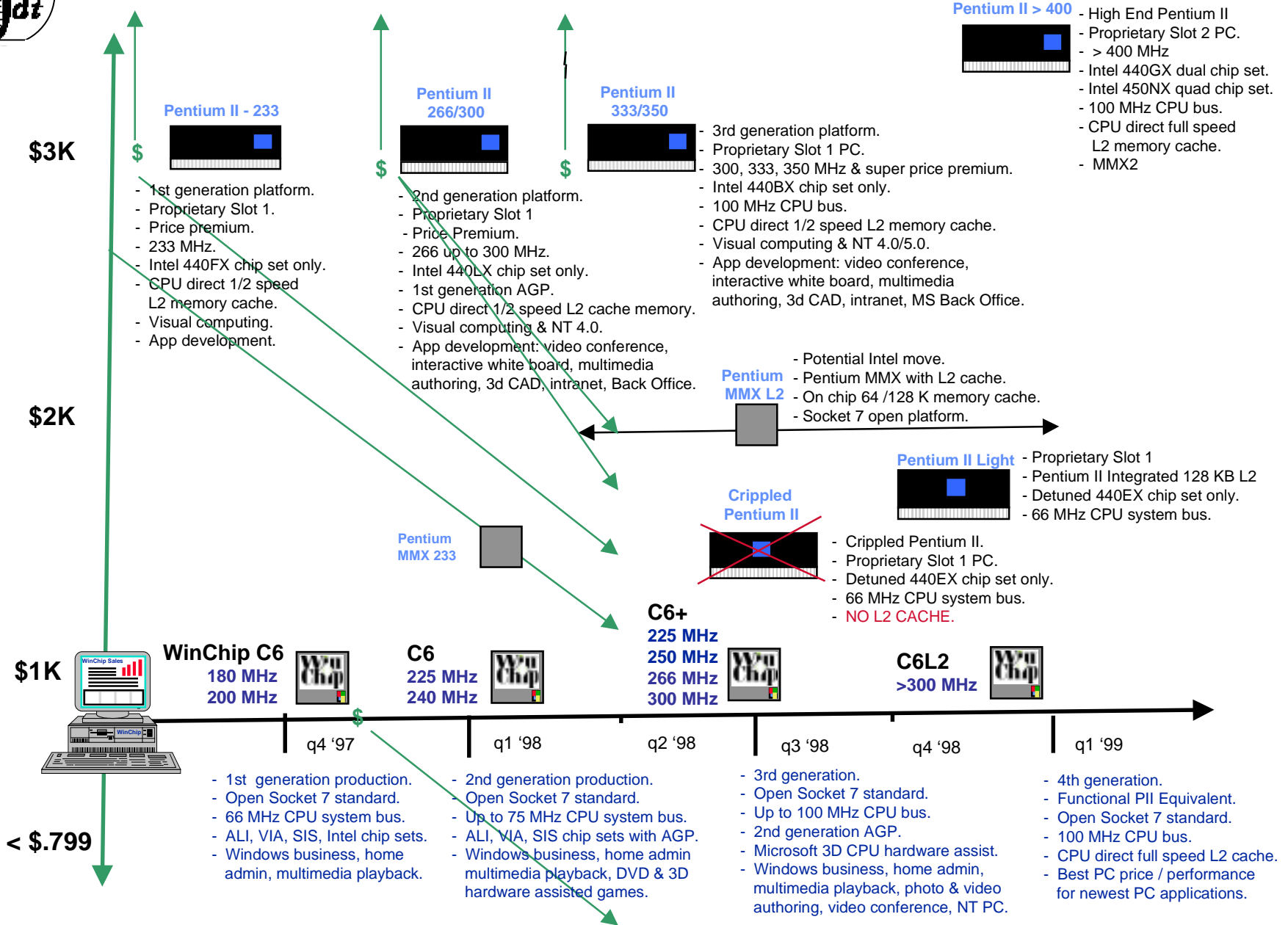



INTEGRATED DEVICE TECHNOLOGY

Pentium II is a premium priced development platform disguised as a consumer Windows PC - don't be fooled.

As a development platform, Pentium II is 9 to 14 months ahead of PC software evolution.

Approximate trends for discussion only.

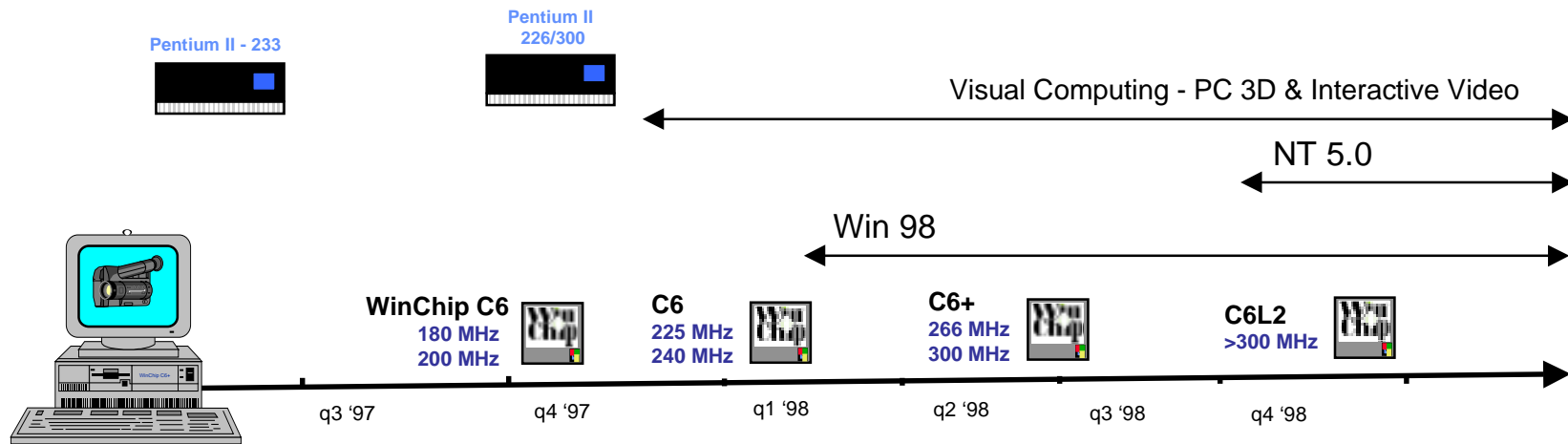

- IDT WinChip delivers best 1998 price/performance for “open” Socket 7 PCs.
- IDT WinChip development is better synchronized with new software intro.
- The newest applications will actually follow new operating systems.
- Compared to Pentium II, IDT WinChip offers a much better price/performance ratio 4 to 6 months out, as new Windows based visual computing applications mature, become stable and worth considering in lieu of bleeding edge hassle.



INTEGRATED DEVICE TECHNOLOGY

Pentium II - Uniqueness that is not valuable to the majority.

“The fact that a firm is unique at something does not necessarily mean it is differentiated. Uniqueness does not lead to differentiation unless it lowers buyer cost or raises buyer performance as perceived by the buyer.

The most pervasive differentiation often stems from sources of value the buyer can perceive and measure, or from difficult to measure sources of value that are extensively signaled (advertised). A good test of value of uniqueness is whether the firm can command and sustain a price premium in selling to well informed buyers.

- Michael Porter, professor of Business Studies, Harvard University

Open market Socket 7 standard Vs proprietary Pentium II.

As a well informed buyer please ask yourself, given the price premium I will pay for a proprietary Intel Pentium II, will it really provide me better performance, in terms of processing capability and lower cost of ownership, compared to a Socket 7 PC, the open market standard.

Between now and the end of the year, IDT and the alternate x86 camp believe the answer to be no. We ask you to examine this issue and decide for yourself.



INTEGRATED DEVICE TECHNOLOGY

The reason is simple . . .

In less than four months, **IDT WinChip** attached to open market standard, **Socket 7** motherboards, will deliver all the performance that today's premium priced **Pentium II** delivers for at least **\$1,000 less**.

That's like paying you **\$225 a month** to wait for a new system that will offer a much longer life.

In general, this is true of **Socket 7** offerings from the entire alternate **x86** camp, with product choice, performance growing as we approach the end of the year.



PC purchase strategy in time of massive change.

- PC hardware is 9 to 14 months ahead of software.
- Through 1998, numerous Socket 7 CPU introductions will blossom into a broad array of powerful PC choices at a greater range of prices.
- New Windows software will evolve and stabilize year end 1998 through 1999.
- Upgrade Strategy:
 - Right now . . . spend the least amount of money possible.
 - Upgrade with single voltage Socket 7 MMX CPU: IDT WinChip 200 & memory to 64 MB*.
 - Upgrade with a commercial CPU MMX upgrade chip: Evergreen MX Pro with WinChip 200.
 - Upgrade with Socket 7 MMX CPU + motherboard: target IDT WinChip 225 & 240 MHz.
 - If you absolutely need a new PC, maximize your investment at the \$899 to \$1,200 Socket 7 performance system price point: IDT WinChip 225 with 75 MHz CPU system bus.
 - Or, hang on to your current PC and get a whole new system in the second half of 1998: IDT WinChip C6+ or IDT WinChip C6L2.

* 64 MB or > for Windows 95



INTEGRATED DEVICE TECHNOLOGY

As a non-commercial CPU upgrade, IDT WinChip C6 has the greatest chance of working in your current motherboard if:

- 1) Motherboard supports Intel 3.52 volt jumper setting.
- 2) Motherboard supports 60x3 (180 MHz), 66x3 (200 MHz) 75x3 (225 MHz) CPU clock settings.
- 3) Motherboard currently uses an Award BIOS.

Note commercial CPU upgrade based on WinChip are available from Evergreen Technologies, including warranty and technical support. For those who purchase the CPU alone, as a non-commercial CPU upgrade, proceed at your own risk. Review your motherboard manual before proceeding. Review frequently asked questions on the www.winchip.com web site. Be knowledgeable of board voltage and CPU clock speed settings. There are no warranties or guarantees and IDT will not replace damaged equipment as a result on a non-commercial upgrade. If statements one through three are true, IDT WinChip C6 should be a drop in Pentium replacement. When installing WinChip ground yourself. Make sure the CPU is properly aligned in the (white) Socket 7 ZIFF socket. Match the white dot on the cut corner of the CPU package with the cut corner of the Socket 7 pin-out. Once installed use a heat sink and fan on top of the CPU. Note that without an Award BIOS update, IDT WinChip C6 will not be properly identified, however, will still deliver 200 MHz core clock speed and MMX functionality. Note, under Windows 95, memory upgrade to 64 MB in parallel with CPU upgrade is recommended for the ultimate in refined performance.

- 4) Motherboard supports flash BIOS.
- 5) Motherboard mfg has licensed, from the BIOS provider, the latest revision of the BIOS supporting board with WinChip C6.
- 6) I have successfully flashed the BIOS.

If statements four through six are true, IDT WinChip C6 should be a drop in Pentium replacement for AMI and Phoenix BIOS boards, when the boards BIOS has been flash updated to support IDT WinChip C6. Upon successful flash, look for "IDT C6" at system boot. Proceed at your own risk. There are no warranties or guarantees and IDT will not replace damaged equipment as a result on a non-commercial upgrade. Read frequently asked questions on www.winchip.com. Review your motherboard board manual for familiarity with voltage and clock speed settings. Before replacing your CPU ground yourself. Make sure the CPU is properly aligned in the (white) Socket 7 ZIFF socket. Match the white dot on the cut corner of the CPU package with the cut corner of the socket pin-out. Once installed use a heat sink and fan on top of the CPU. Note, under Windows 95, memory upgrade to 64 MB in parallel with CPU upgrade is recommended for the ultimate in refined performance.



INTEGRATED DEVICE TECHNOLOGY

As a non-commercial CPU upgrade, IDT WinChip C6 has the greatest chance of working in your current motherboard if:

- 7) Motherboard has an old AMI BIOS that is not flashable or supported by the board manufacturer with the latest IDT WinChip supported revision.

In some cases, for some systems, WinChip C6 will operate with an older AMI BIOS motherboard (similar to older Award BIOS motherboards) which cannot be flashed, or has a chip set that is no longer supported with the latest BIOS revision by the board manufacturer. Essentially the only way to find out is to set the board voltage and speed settings as previously described and try. Proceed at your own risk. There are no warranties or guarantees and IDT will not replace damaged equipment as a result on a non-commercial upgrade. Read frequently asked questions on www.winchip.com. Review your motherboard board manual for familiarity with voltage and clock speed settings. Before replacing your CPU ground yourself. Make sure the CPU is properly aligned in the (white) Socket 7 ZIFF socket. Match the white dot on the cut corner of the CPU package with the cut corner of the socket pin-out. Once installed use a heat sink and fan on top of the CPU. Note, under Windows 95, memory upgrade to 64 MB in parallel with CPU upgrade is recommended for the ultimate in refined performance.

- 8) Motherboard is Intel manufactured and branded.

If statement 8 is true, IDT WinChip C6 likely will not be recognized and the board may not be upgraded with other than an Intel processor. Intel manufactured Socket 7 motherboards include a BIOS, licensed to Intel by the board manufacturer, that will in most cases, only allow the motherboard to boot when attached to an Intel processor. Intel motherboards, in most cases, do not work with alternate x86 CPUs from any manufacturer.

- 9) Upon reading this you may decide that a non-commercial CPU upgrade is not for you. There are two alternate upgrade paths:

- A) Commercial CPU upgrade based on IDT WinChip C6 from Evergreen Technologies including warranty and support.

- B) IDT WinChip CPU upgrade attached to a new Socket 7 motherboard. See www.winchip.com for motherboard compatibility list. Motherboard upgrade assure IDT WinChip attachment to the latest board and chip set designs.



INTEGRATED DEVICE TECHNOLOGY

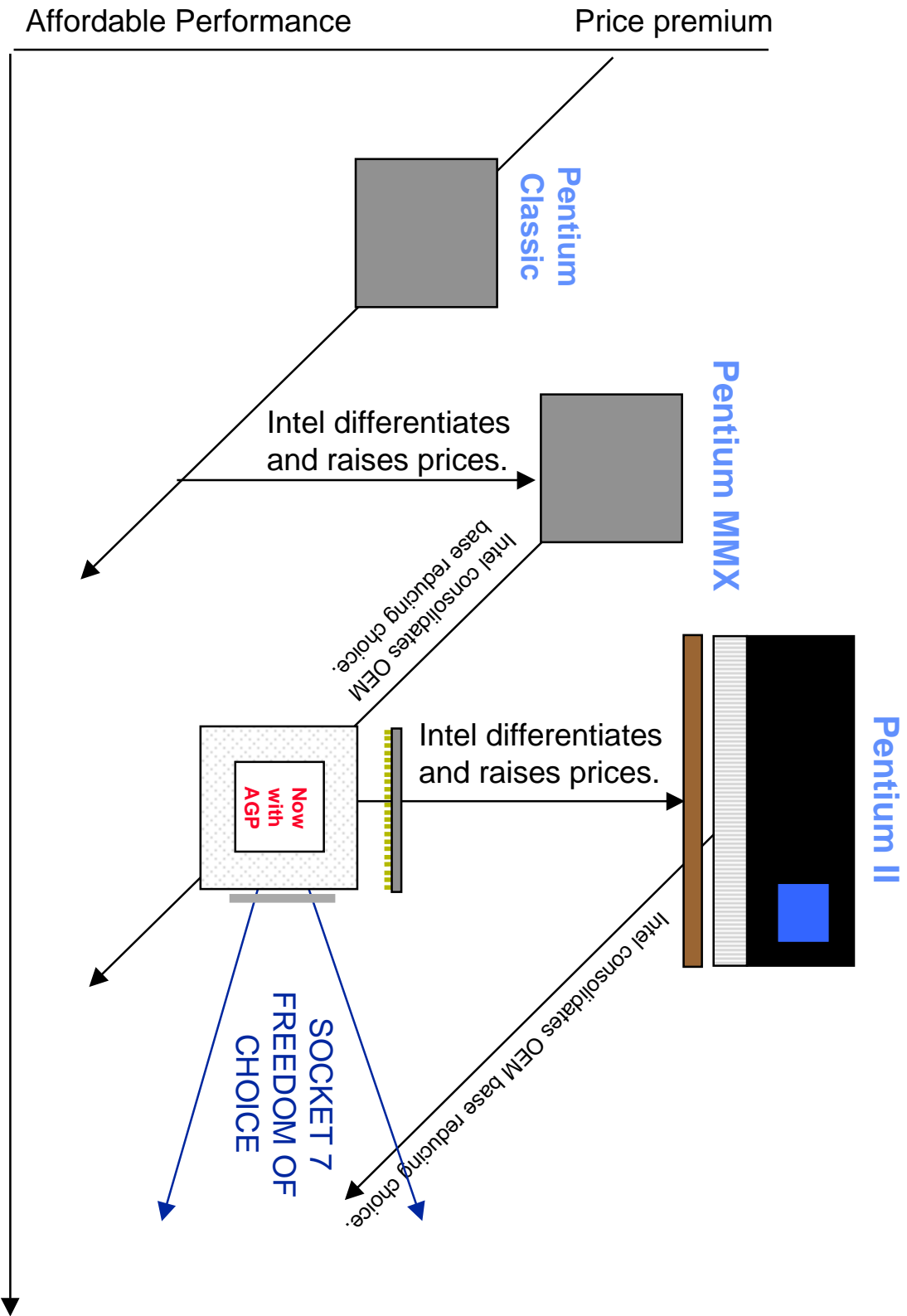

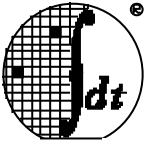

INTEGRATED DEVICE TECHNOLOGY

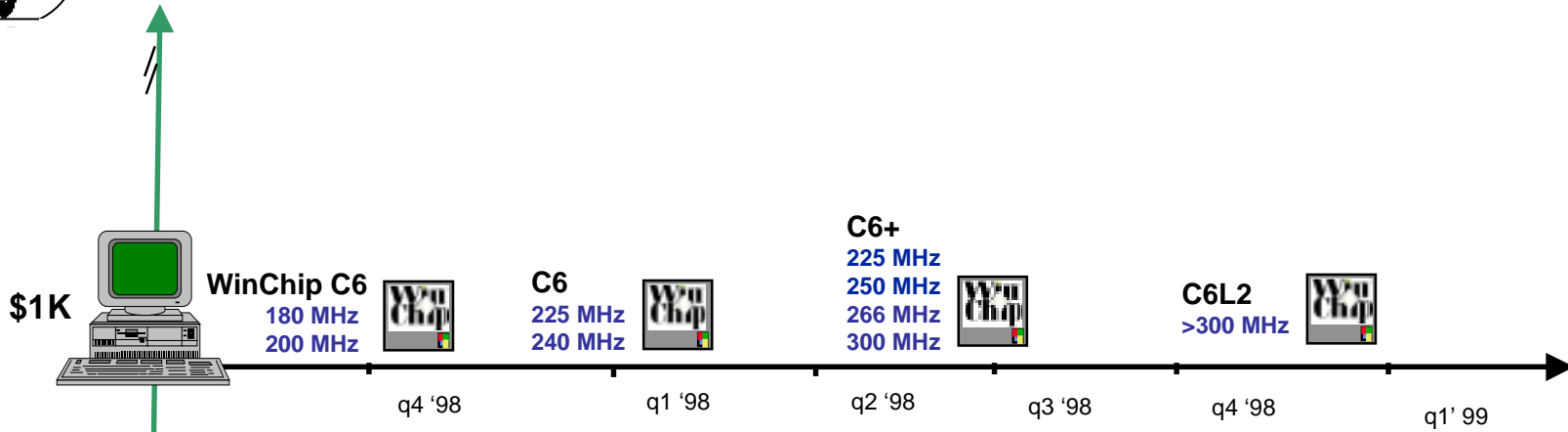

< \$799



- Integrated CPU.
- CPU soldered on motherboard.
- Modest Platform expansion.

< \$599



POTENTIAL <\$599 PC DERIVATIVE PLATFORM

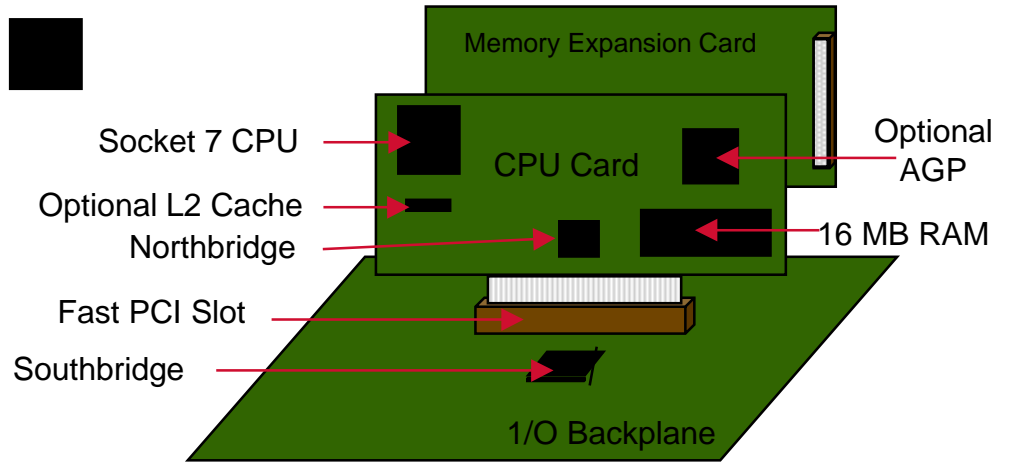

< \$499

Low cost PC path.

Sub \$799 system is speculative & for discussion - Do your own research.



INTEGRATED DEVICE TECHNOLOGY

Intel does not have a notebook CPU solution beyond 266 MHz.

Intel can't match IDT WinChip notebook price / performance.

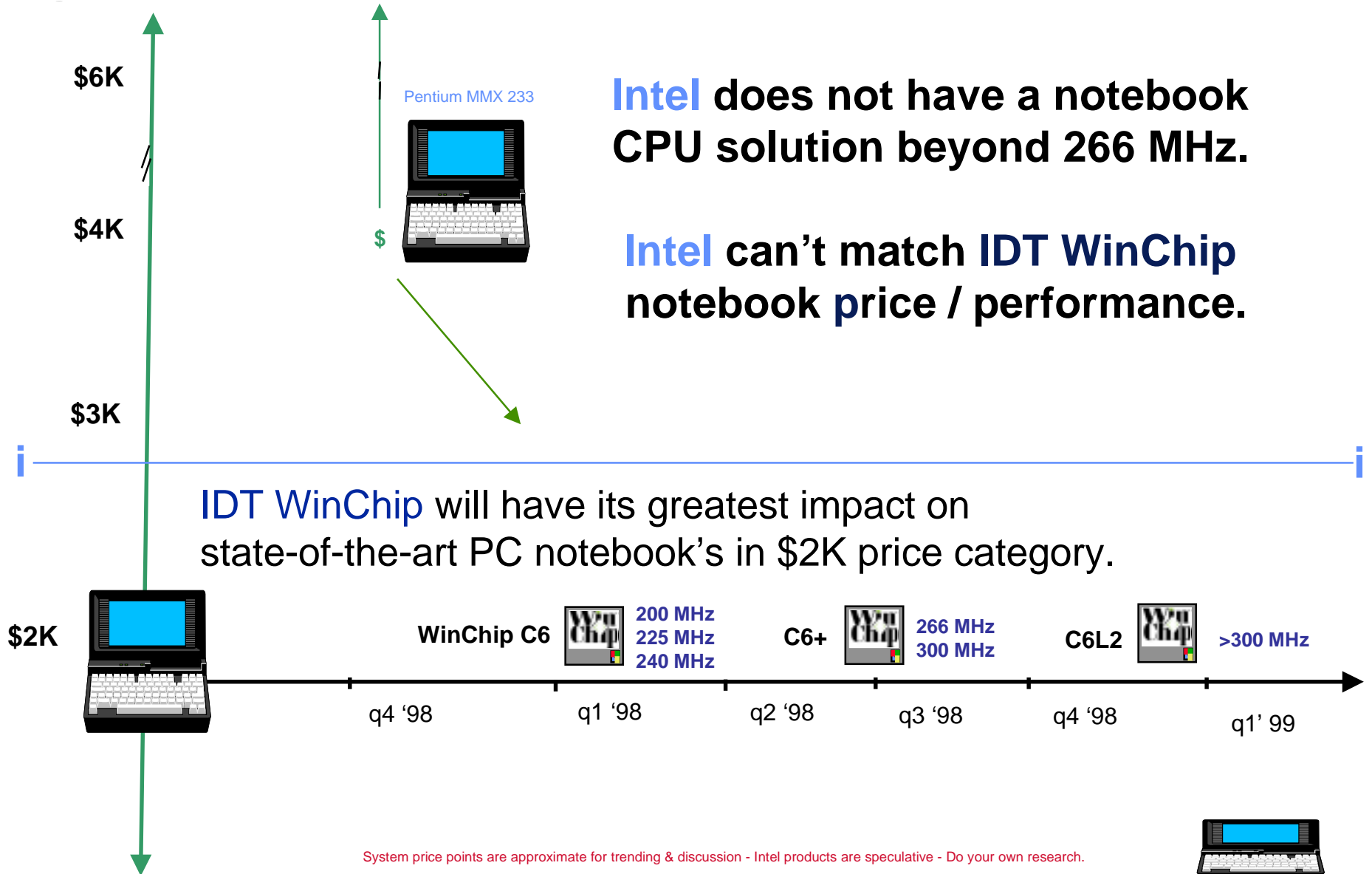



INTEGRATED DEVICE TECHNOLOGY

IDT WinChip C6 200 / 225 Available Now



- Price / performer for < \$1,000 desktops.
- Low power for < \$2,000 notebooks.
- Comparable WinStone 97 performance to **Intel**, **AMD**, **Cyrix**.
- Plugs into low cost, widely accepted, Socket 7 motherboards.
- Optimized for Windows business applications.



IDT WinChip C6+ Available Late Q2 1998

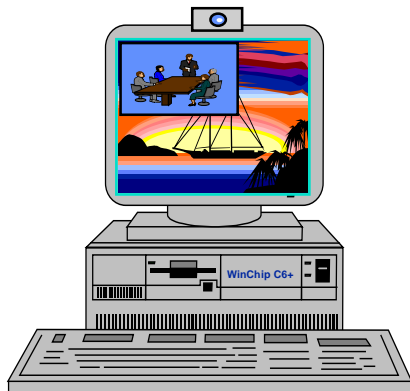

- < \$1,500 visual computing: 3D game, video conference, photo editing, movies.
- 6% integer performance improvement over **WinChip C6**.
- 2x C6 floating point performance - Equal to Intel.
- 2x C6 MMX performance - C6 with superscalar **MMX**.
- Spectacular 3D and AGP graphics performance.
- Plugs into Socket 7 boards with 66, 75, 83.8 & 100 MHz CPU bus.

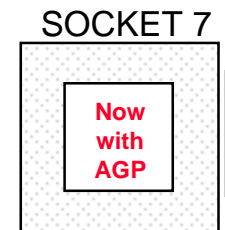



INTEGRATED DEVICE TECHNOLOGY

APCUG will host your group's web page - 5 MB space.

APCUG Affiliate Group Web Page Host Server

donated by **IDT / Centaur**

**Contact Don Singleton
President, Tulsa Computer Society
for details:**

**djs@ionet.net
or
918 / 622-3417**



For user group discount system and board deals see <http://www.aestechnology.com/usergroup.html>

mb 2/8/98

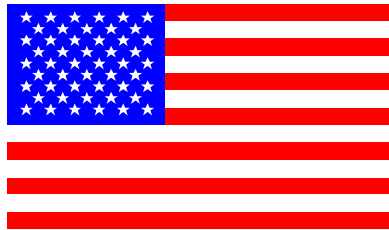

Before your buy please consider the benefits of the “open market standard” “PC standard” Socket 7.



Support Socket 7 PCs, alternate x86 microprocessor companies ([IDT/Centaur](#), [AMD](#), [Cyrix](#)) plus their chipset (ALI, ETEQ, SIS, OPTI, VIA) and motherboard partners. These companies are investing millions of dollars to maintain an open PC standard, free market, freedom of choice, fair market pricing and U.S. gross domestic product. Don't be fooled by the [Intel](#) (trust) monopoly.

[Alternate x86 CPU companies thank you.](#)