

# **POWERLEAP™ PL-K6-III/98**

## **Pentium® CPU Upgrade Kit**

- Intel Pentium (P54C) and Pentium w/MMX Technology (P55C)
  - AMD K6, K6-2, and K6-III
- Cyrix/IBM 6X86, 6X86L, 6X86MX, and MII
  - IDT C6 and WinChip2

VERSION 1.XX

Copyright © 1999 PowerLeap Products, Inc.

All Rights Reserved.

March 1999

The information in this document is subject to change without prior notice in order to improve reliability, design and function and does not represent a commitment on the part of the manufacturer.

In no event will the manufacturer be liable for direct, indirect, special, incidental, or consequential damages arising out of the use or inability to use the product or documentation, even if advised of the possibility of such damages.

Product names mentioned herein are used for identification purposes only and may be trademarks and/or registered trademarks of their respective companies.

This product employs patented technology (Japanese Registered Utility Model No. 3042946).

Visit our web site at:

<http://www.powerleap.com>

### **Some Commonly Used Abbreviations**

This manual uses the following abbreviations and acronyms.

**MMX:** Multimedia Extension

**P54C:** Intel Pentium CPU

**P55C:** Intel Pentium with MMX CPU

# Table of Contents

<b>Introduction</b>	<b>1</b>
About the MMX™ Technology _____	1
About the 3DNow!™ Technology _____	1
Special Features _____	2
What You Have _____	2
<b>The PowerLeap™ PL-K6-III/98</b>	<b>3</b>
Quick Start: CPU Settings _____	3
SW1 Settings: Clock Multiplier, CPU Voltage, and CPU Overheating Protection _____	8
SW1: Pins 1, 2, & 3 (Clock Multiplier)	8
SW1: Pins 4, 5, 6, 7, & 8 (Core Voltage)	9
SW1: Pin 10 (CPU Overheating Protection)	10
<b>Installing the CPU Upgrade Board</b>	<b>11</b>
Before Installation _____	11
Installation _____	12
<b>Technical Reference</b>	<b>21</b>
SW1: Core Voltage Settings _____	25
<b>Downloading PowerLeap Software</b>	<b>27</b>

## Table of Figures

Figure 1. The PL-K6-III/98_____	11
Figure 2. Removing the existing CPU and CPU cooling fan _____	13
Figure 3. Sliding the CPU onto the CPU plate _____	14
Figure 4. Tightening the hex nuts_____	15
Figure 5. Inserting the CPU into the upgrade board_____	16
Figure 6. Checking the DIP switch settings _____	17
Figure 7. Installing the CPU upgrade board into the ZIF socket _____	18
Figure 8. Locking the CPU upgrade board into the ZIF socket _____	19
Figure 9. Connecting the power cable _____	20

## Introduction

Your PowerLeap™ PL-K6-III/98 CPU upgrade board allows Pentium Socket 5 and Socket 7 systems to take advantage of the latest 3DNOW! & MMX CPU technology from AMD, Intel, Cyrix, and IDT.

The CPU upgrade board employs *patented* technology to adapt Socket 5 and Socket 7 systems to the voltage and pinout requirements of this new generation of processors. It provides an upgrade solution that would otherwise require the replacement of the motherboard.

### About the MMX™ Technology

Intel's MMX technology extends the performance of Pentium processors with 57 new instructions, a 32K L1 cache, four new 64-bit data types, and more. For multimedia and communications applications, MMX can significantly enhance audio/video playback and image processing. MMX technology is compatible with a wide range of existing operating systems (including MS-DOS, Windows, OS/2, and UNIX) and 16/32-bit applications.

### About the 3DNow!™ Technology

AMD's 3DNow! technology is an innovative group of 21 new instructions for the x86 architecture that brings powerful performance enhancements for multimedia and floating-point-intensive applications. With 3DNow! technology, applications can achieve more detailed 3D imaging, faster frame rates for video playback, and dramatic improvements in audio. 3DNow! technology appears in the AMD K6-III & K6-2 processor and works with all existing operating systems and x86 applications.

## Special Features

PowerLeap PL-K6-III/98 offers the following advanced features:

- Supports both Socket 5 and Socket 7 Pentium systems' MMX-Enabled CPU upgrade
- Supports Intel Pentium, Pentium w/MMX, AMD K6, K6-2, K6-III, Cyrix/IBM 6x86L, 6x86MX, MII, IDT C6 and WinChip2 CPUs
- Provides chip-for-chip replacement, with no software drivers to install
- Employs the patented IPS (Independent Power Source) technology, which provides pure, abundant, and durable power to the V/Core of split-voltage type CPUs
- Supports AMD K6-III w/Internal 1:1, 256-KByte L2 cache
- Includes switching VRM (Voltage Regulating Module) circuitry
- Provides large on-chip 64KB L1 cache (AMD K6, K6-2, K6-III, Cyrix/IBM 6x86MX, MII, IDT-C6, and WinChip2) or 32KB L1 cache (Intel Pentium w/MMX) for high-performance implementation
- Offers a unique *CPU overheating protection* function
- Delivers the most cost-effective MMX CPU upgrade solution

## What You Have

Your PowerLeap™ PL-K6-III/98 CPU upgrade kit includes the following items:



- The PowerLeap™ PL-K6-III/98 upgrade board
- Power connector cord
- PowerLeap™ Utility Diskette (CPU Control Panel software)
- CPU cooling fan & heatsink

## The PowerLeap™ PL-K6-III/98

This chapter describes setting the clock multiplier and voltages for your PowerLeap PL-K6-III/98 CPU upgrade board.

### Quick Start: CPU Settings

This section shows how to use the SW1 DIP switch to choose the correct clock multiplier and voltages for your new Intel, AMD, IDT, or Cyrix/IBM processor.

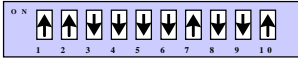
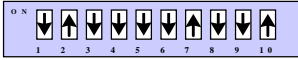
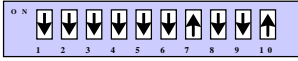
Intel CPU	SW1 Settings
Pentium-166 (66/2.5x)	
Pentium-200 (66/3.0x)	
Pentium w/MMX-166 (66/2.5x)	
Pentium w/MMX-200 (66/3.0x)	
Pentium w/MMX-233 (66/3.5x)	

AMD K6 CPU	SW1 Settings
K6-166 (66/2.5x)	
K6-200 (66/3.0x)	
K6-233 (66/3.5x)	
K6-266 (66/4.0x)	
K6-300 (66/4.5x)	

AMD K6-2 CPU	SW1 Settings
K6-2 /266 (66/4.0x)	
#K6-2 /266 (75/3.5x)	
K6-2 /300 (66/4.5x)	
#K6-2 /300 (75/4.0x)	
K6-2 /333 (66/5.0x)	
#K6-2 /333 (75/4.5x)	
K6-2 /366 (66/5.5x)	

# For systems with an external clock speed faster than 66MHz.



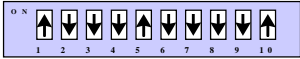
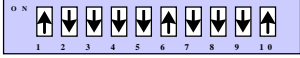

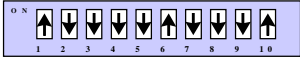

AMD K6-2 CPU	SW1 Settings
#K6-2 380 (75/5.0x)	
K6-2 400 (66/6.0x)	
#K6-2 450 (75/6.0x)	





# For systems with an external clock speed faster than 66MHz.

AMD K6-III CPU	SW1 Settings
K6-III 400 (66/6.0x)	
#K6-III 450 (75/6.0x)	

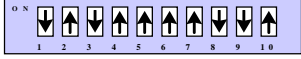

# For systems with an external clock speed faster than 66MHz.

IDT CPU	SW1 Settings
C6 MMX-180 (60/3.0x)	
C6 MMX-200 (66/3.0x)	
#C6 MMX-225 (75/3.0x)	
C6 MMX-240 (60/4.0x)	

# For systems with an external clock speed faster than 66MHz.

IDT CPU	SW1 Settings
#WinChip2-225 (75/3.0x)	
WinChip2-240 (60/4.0x)	
#WinChip2-250 (83/3.0x)	
WinChip2-266 (66/4.0x)	
#WinChip2-300 (75/4.0x)	

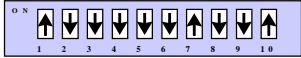
# For systems with an external clock speed faster than 66MHz.

Cyrix/IBM 6x86L CPU	SW1 Settings
6x86L-P150+ (60/2.0x)	
6x86L-P166+ (66/2.0x)	
#6x86L-P200+ (75/2.0x)	

# For systems with an external clock speed faster than 66MHz.

Cyrix/IEM 6x86MX CPU	SW1 Settings
6x86MX-PR166GP (60/2.5x)	
6x86MX-PR200GP (66/2.5x)	
#6x86MX-PR200GP (75/2.0x)	
6x86MX-PR233GP (66/3.0x)	
#6x86MX-PR233GP (75/2.5x)	
#6x86MX-PR266GP (83/2.5x)	

# For systems with an external clock speed faster than 66MHz.

Cyrix/IBM MII CPU	SW1 Settings
MII-300GP (66/3.5x)	
#MII-300GP (75/3.0x)	
#MII-333GP (75/3.5x)	

# For systems with an external clock speed faster than 66MHz.

## SW1 Settings: Clock Multiplier, CPU Voltage, and CPU Overheating Protection

This section shows the SW1 clock multiplier and voltage settings for Intel, AMD, Cyrix/IBM, and IDT CPUs. To reduce power consumption, dual-voltage CPUs use two separate supply voltages: an I/O interface voltage and a lower core voltage for the processor.

### SW1: Pins 1, 2, & 3 (Clock Multiplier)

Pins 1, 2, & 3: Clock Multiplier for P55C, K6, K6-2, K6-III, 6X86MX, MII (Dual-Voltage), C6, WinChip2, and P54C (Single-Voltage)								
CLKMUL	6x	5.5x	5x	4.5x	4x	3.5x	3x	2.5x
SW1: Pin 1	ON	OFF	OFF	ON	ON	OFF	OFF	ON
SW1: Pin 2	OFF	OFF	ON	ON	OFF	OFF	ON	ON
SW1: Pin 3	OFF	ON	ON	ON	ON	OFF	OFF	OFF

Pins 1 & 2 : Clock Multiplier for 6X86 (Single-Voltage) and 6X86L (Dual-Voltage)	
CLKMUL	2x
SW1: Pin 1	ON
SW1: Pin 2	OFF
SW1: Pin 3	OFF

**SW1: Pins 4, 5, 6, 7, & 8 (Core Voltage)**

Pins 4, 5, 6, 7, & 8: Core Voltage for Pentium P54C/P55C, AMD K6/K6-2 /K6-III, IDT C6/WinChip2, and Cyrix/IBM 6X86/6X86L/6X86MX/MII							
Core Voltage	3.5V	3.3V	3.2V	2.9V	2.8V	2.4V	2.2V
CPU TYPE	C6 WinChip-2	P54C 6X86	K6-233	K6-200 6x86MX MII	P55C 6X86L	K6-2/450 K6-III	K6-266 K6-300 K6-2
SW1: Pin 4	ON	ON	OFF	ON	OFF	OFF	OFF
SW1: Pin 5	ON	OFF	OFF	OFF	OFF	OFF	ON
SW1: Pin 6	ON	ON	ON	OFF	OFF	ON	OFF
SW1: Pin 7	ON	ON	ON	ON	ON	OFF	OFF
SW1: Pin 8	OFF	OFF	OFF	OFF	OFF	OFF	OFF

\* Note the actual voltage printed on the CPU label.

**For systems with an external clock speed of less than 66MHz (50MHz or 60MHz), there may be a slight performance sacrifice for your new CPU. For example, changing to a K6-166 from a Pentium-75 will result in a system upgrade speed of 150MHz (not 166MHz). In this case, you can get improved performance by adjusting the external clock speed to 66MHz.**

### SW1: Pin 10 (CPU Overheating Protection)

The CPU upgrade board offers a unique *CPU overheating protection* function that can prevent damage to your CPU if the temperature increases. When this function is enabled, the CPU speed will automatically drop 60% if the CPU temperature reaches 70°C or higher. This prevents the CPU from overheating.

CPU Overheating Protection	
SW1: Pin 10	CPU Overheating Protection
ON	Enabled
OFF	Disabled

## Installing the CPU Upgrade Board

This chapter describes installing your CPU upgrade board.

### Before Installation

Prior to starting installation, take your CPU upgrade board from its packing and remove the protective foam pad, taking care not to damage the pins. If the package includes a CPU cooling fan & heatsink, remove it too.

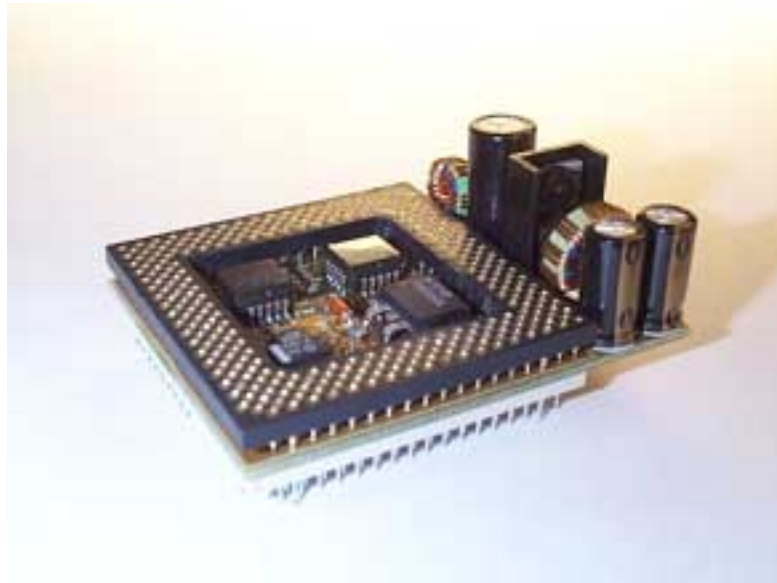

Figure 1. The PL-K6-III/98

To compare the performance increase provided by the PL-K6-III/98 CPU upgrade board, we suggest running the PowerLeap CPU Control Panel® both before and after installation. If you are uncertain about the speed of your existing CPU, you can determine the speed by running the PowerLeap CPU Control Panel®.

## Installation

If your package came with a CPU cooling fan & heatsink, install the CPU upgrade board as follows.

### ➔ To install the CPU upgrade board:

1. Place your computer where you will have plenty of space to work.
2. **Turn the computer off and disconnect all power cords and cables from the rear of the computer.**
3. Remove the cover from the computer (as described in the computer documentation).
4. Locate your existing CPU on the computer's motherboard. The CPU will be clearly labeled with the manufacturer's name (such as "Intel"), and markings identifying the CPU model and speed (such as Pentium-75).
5. Remove the existing CPU cooling fan.



6. Remove the existing CPU from the ZIF socket.

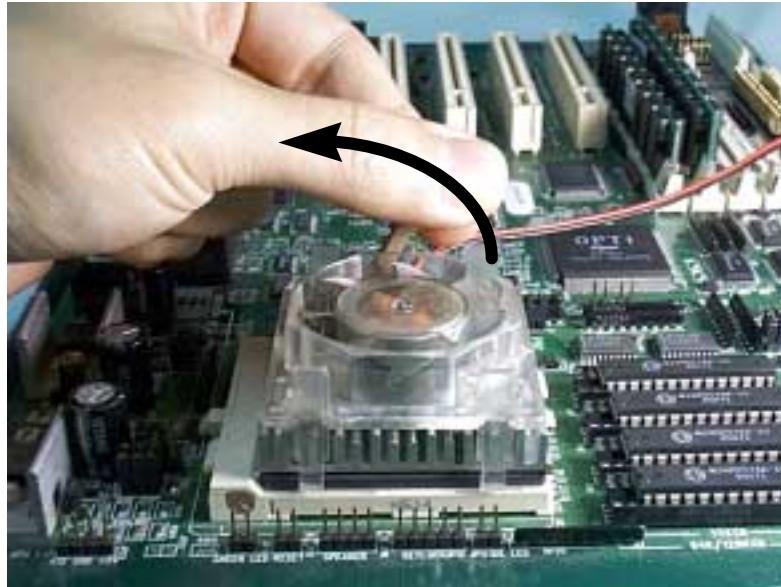

**Figure 2. Removing the existing CPU and CPU cooling fan**

7. Hold the provided CPU cooling fan & heatsink so that the CPU plate faces upward.
8. Loosen the hex nuts at each corner of the CPU cooling fan. You should be able to freely move the CPU plate up and down.

9. Turn your new CPU over (so that the pins are facing upward) and slide it under the grooves at the sides of the CPU plate.

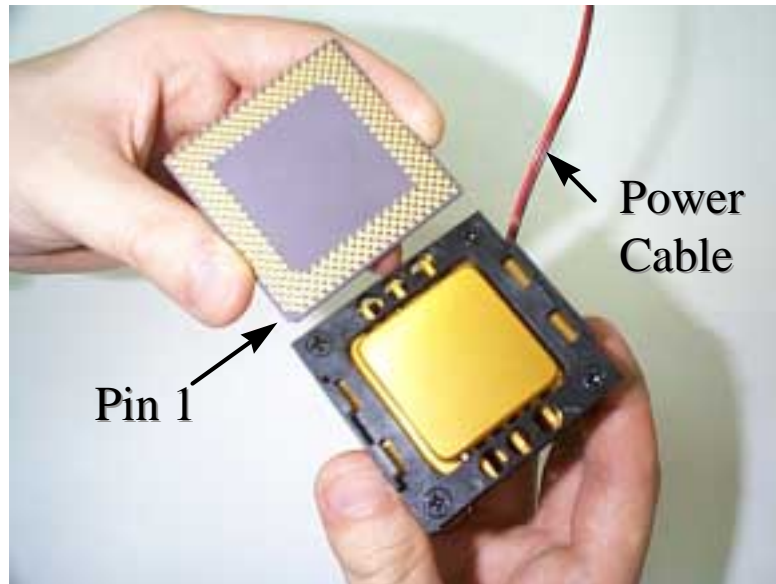

Figure 3. Sliding the CPU onto the CPU plate

**Pin 1 of the CPU must occupy the corner diagonally opposite the fan's power cable. If necessary, remove the CPU from the CPU plate and insert it again, with pin 1 in the correct position.**

10. Tighten the hex nuts. The CPU should be firmly attached to the CPU plate.



Figure 4. Tightening the hex nuts

11. Turn the CPU cooling fan & heatsink over and insert the CPU into the upgrade board, **making sure that pin 1 of the CPU corresponds to pin 1 of the upgrade board.** *Be sure the CPU is firmly seated in the board.*

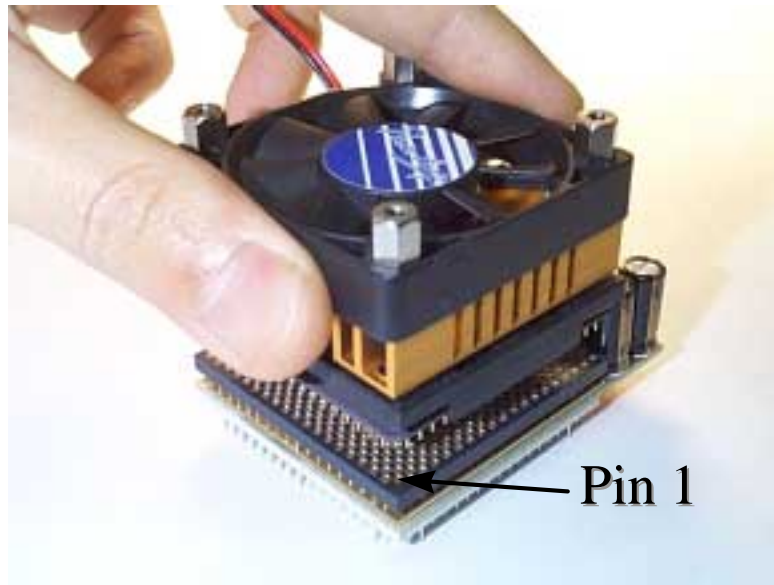

Figure 5. Inserting the CPU into the upgrade board

12. Make sure the CPU upgrade board's DIP switch settings are correct.

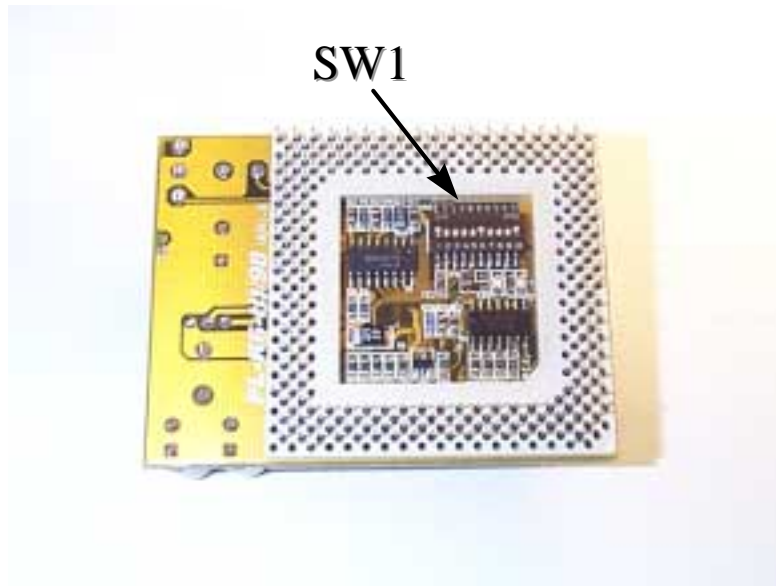

Figure 6. Checking the DIP switch settings

13. Install the CPU upgrade board into your computer's ZIF socket, **making sure that pin 1 of the upgrade board is installed in pin 1 of the ZIF socket.**

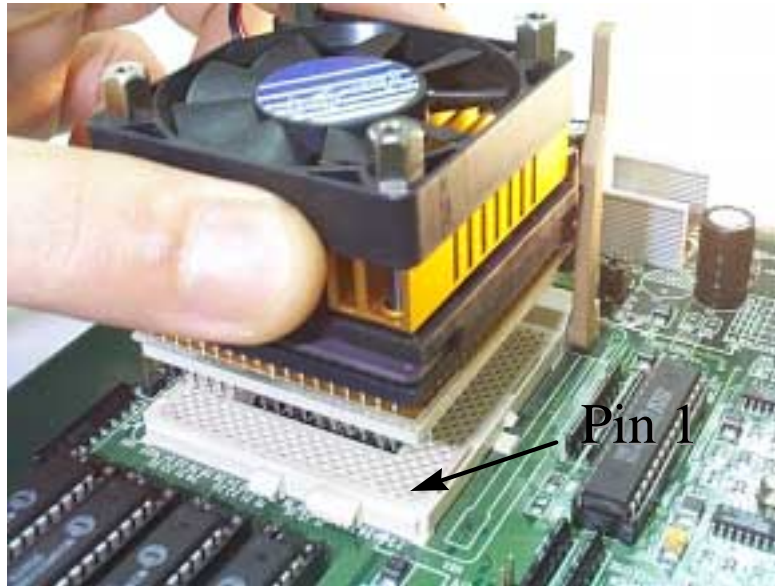

Figure 7. Installing the CPU upgrade board into the ZIF socket

**Pin 1 of the CPU upgrade board must match the pin 1 hole of the ZIF socket. If the upgrade board is installed incorrectly, it may be damaged.**

14. Lock the CPU upgrade board into the ZIF socket by pressing the socket arm down.



Figure 8. Locking the CPU upgrade board into the ZIF socket

15. Plug the PL-K6-III/98's power cable and fan's power cable into the power connector and fan connector on the CPU upgrade board.

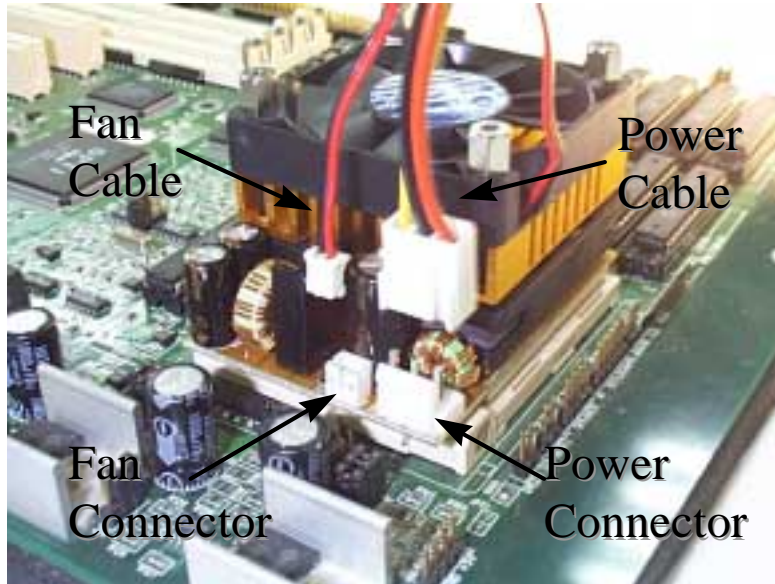

Figure 9. Connecting the power cable

The CPU upgrade board must have an independent (external) power supply in order to operate. Without a connection to an external power supply, the CPU upgrade will not work.

For maximum reliability, do not use the unused connector on the power connector cord to supply power to a hard disk drive or other device. In other words, use the power connector cord to connect only the upgrade board to the power supply.



## Technical Reference

You can achieve the best CPU performance by adjusting the system board's external clock speed according to the tables below. Or use the formula below to calculate the PL-K6-III/98 board's clock multiplier.

***System Upgrade Speed = External Clock Speed x Upgrade Board Clock Multiplier***

Intel CPU	External Clock Speed	Upgrade Board Clock Multiplier	Internal Clock Speed
Pentium - 75	50 MHz	1.5x	75 MHz
Pentium - 90	60 MHz	1.5x	90 MHz
Pentium - 100	66 MHz	1.5x	100 MHz
Pentium - 120	60 MHz	2x	120 MHz
Pentium - 133	66 MHz	2x	133 MHz
Pentium - 150	60 MHz	2.5x	150 MHz
Pentium -166	66 MHz	2.5x	166 MHz
Pentium - 200	66 MHz	3x	200 MHz
P55C MMX - 166	66 MHz	2.5x	166 MHz
P55C MMX - 200	66 MHz	3x	200 MHz
P55C MMX - 233	66 MHz	3.5x	233 MHz

AMD CPU	External Clock Speed	Upgrade Board Clock Multiplier	Internal Clock Speed
K6-166	66 MHz	2.5x	166 MHz
K6-200	66 MHz	3x	200 MHz
K6-233	66 MHz	3.5x	233 MHz
K6-266	66 MHz	4x	266 MHz
K6-300	66 MHz	4.5x	300 MHz
K6-2 /233	66 MHz	3.5x	233 MHz
K6-2 /233	75 MHz	3x	225 MHz
K6-2 /266	66 MHz	4x	266 MHz
K6-2 /266	75 MHz	3.5x	266 MHz
K6-2 /300	66 MHz	4.5x	300 MHz
K6-2 /300	75 MHz	4x	300 MHz
K6-2 /333	66 MHz	5x	333 MHz
K6-2 /333	75 MHz	4.5x	337 MHz
K6-2 /366	66 MHz	5.5x	366 MHz
K6-2 /380	75 MHz	5x	375 MHz
K6-2 /400	66 MHz	6x	400 MHz
K6-2 /450	75 MHz	6x	450 MHz
K6-III /400	66 MHz	6x	400 MHz
K6-III /450	75 MHz	6x	450 MHz

IDT CPU	External Clock Speed	Upgrade Board Clock Multiplier	Internal Clock Speed
C6 - 180	60 MHz	3x	180 MHz
C6 - 200	66 MHz	3x	200 MHz
C6 - 2 25	75 MHz	3.5x	225 MHz
C6 - 240	60 MHz	4x	240 MHz
WinChip2 - 225	75MHz	3x	225 MHz
WinChip2 - 240	60MHz	4x	240 MHz
WinChip2 - 250	83MHz	3x	250 MHz
WinChip2 - 266	66MHz	4x	266 MHz
WinChip2 - 300	75MHz	4x	300 MHz

Cyrix/IBM CPU	External Clock Speed	Upgrade Board Clock Multiplier	Internal Clock Speed
6x86 - P120+	50 MHz	2x	100 MHz
6x86 - P133+	55 MHz	2x	110 MHz
6x86 - P150+	60 MHz	2x	120 MHz
6x86 - P166+	66 MHz	2x	133 MHz
6x86 - P200+	75 MHz	2x	150 MHz
6x86L - P120+	50 MHz	2x	100 MHz
6x86L - P133+	55 MHz	2x	110 MHz
6x86L - P150+	60 MHz	2x	120 MHz
6x86L - P166+	66 MHz	2x	133 MHz
6x86L - P200+	75 MHz	2x	150 MHz
6x86MX - PR166	60 MHz	2.5x	150 MHz

Cyrix/IBM CPU	External Clock Speed	Upgrade Board Clock Multiplier	Internal Clock Speed
6x86MX - PR200	66 MHz	2.5x	166 MHz
6x86MX - PR200	75 MHz	2x	150 MHz
6x86MX - PR233	75 MHz	2.5x	188 MHz
6x86MX - PR233	66 MHz	3x	200 MHz
6x86MX - PR266	83 MHz	2.5x	207 MHz
MII-300GP	66 MHz	3.5x	233 MHz
MII-333GP	75 MHz	3.5x	263 MHz

For systems with an external clock speed slower than 50MHz, there may be a slight performance sacrifice for your new CPU. For example, changing to a K6-166 from a Pentium-75 will result in a system upgrade speed of 150MHz (not 166MHz).

### SW1: Core Voltage Settings

VCC2 Voltage	Pin 4	Pin 5	Pin 6	Pin 7	Pin 8
3.5V	ON	ON	ON	ON	OFF
3.4V	OFF	ON	ON	ON	OFF
3.3V	ON	OFF	ON	ON	OFF
3.2V	OFF	OFF	ON	ON	OFF
3.1V	ON	ON	OFF	ON	OFF
3.0V	OFF	ON	OFF	ON	OFF
2.9V	ON	OFF	OFF	ON	OFF
2.8V	OFF	OFF	OFF	ON	OFF
2.7V	ON	ON	ON	OFF	OFF
2.6V	OFF	ON	ON	OFF	OFF
2.5V	ON	OFF	ON	OFF	OFF
2.4V	OFF	OFF	ON	OFF	OFF
2.3V	ON	ON	OFF	OFF	OFF
2.2V	OFF	ON	OFF	OFF	OFF
2.1V	ON	OFF	OFF	OFF	OFF
2.0V	OFF	OFF	OFF	OFF	OFF
2.05V	ON	ON	ON	ON	ON
2.00V	OFF	ON	ON	ON	ON
1.95V	ON	OFF	ON	ON	ON
1.90V	OFF	OFF	ON	ON	ON
1.85V	ON	ON	OFF	ON	ON
1.80V	OFF	ON	OFF	ON	ON

VCC2 Voltage	Pin 4	Pin 5	Pin 6	Pin 7	Pin 8
1.75V	ON	OFF	OFF	ON	ON
1.70V	OFF	OFF	OFF	ON	ON
1.65V	ON	ON	ON	OFF	ON
1.60V	OFF	ON	ON	OFF	ON
1.55V	ON	OFF	ON	OFF	ON
1.50V	OFF	OFF	ON	OFF	ON
1.45V	ON	ON	OFF	OFF	ON
1.40V	OFF	ON	OFF	OFF	ON
1.35V	ON	OFF	OFF	OFF	ON
1.30V	OFF	OFF	OFF	OFF	ON

## Downloading PowerLeap Software

The PowerLeap web site (<http://www.powerleap.com/download.htm>) contains links to files available for FTP download, including:

- PowerLeap CPU Control Panel and the PL/586 Write-back Cache Driver for Windows 95/98. This is the contents of the distribution diskette that is include with the PL/586-133, PL/54C, PL/OD54C, PL/ProMMX, PL/ProMMX Plus, and PL-K6-III/98 products.
- PL/586 Installation Software for DOS/Windows 3.x.
- PL/386 Installation Software for DOS/Windows 3.x.
- WinTune 99 Benchmark. *Windows Magazine's* latest version of the WinTune benchmark, which is handy for before-after comparisons. Requires Windows 95/98/NT.

