



US00D339111S

United States Patent [19]

[11] Patent Number: **Des. 339,111**

Cooke et al.

[45] Date of Patent: **** Sep. 7, 1993**

[54] **COMPUTER HOUSING**

D. 308,515 6/1990 Stead D14/100
D. 308,517 6/1990 Horie D14/109

[75] Inventors: **Kevin K. Cooke**, Delray Beach; **Myron F. Davis**, Boca Raton; **Dennis Crompton**, Delray Beach; **John R. Dewitt**; **Terry M. Espersen**, both of Boca Raton; **Paul J. Galinis**, Boynton Beach; **Paul A. Kerezman**, Royal Pal Beach; **Lau H. Nguyen**, Deerfield Beach, all of Fla.; **Victor V. Zaderej**, North Haven, Conn.

OTHER PUBLICATIONS

Computer Products; Jun. 1988 p. 19; Falco Unix-Based Multiuser Microcomputer; Computer Box Group 290. Wang Direct; Spring 1987 p. 11 of Insert "System Peripherals and Upgrades" LIS 24 Laser Imaging Sys. Computer Box Group 290.

[73] Assignee: **International Business Machines Corporation**, Armonk, N.Y.

Primary Examiner—Wallace R. Burke
Assistant Examiner—Freda S. Nunn
Attorney, Agent, or Firm—George E. Grosser

[**] Term: **14 Years**

[57] **CLAIM**

[21] Appl. No.: **425,882**

The ornamental design for a computer housing, as shown and described.

[22] Filed: **Oct. 23, 1989**

DESCRIPTION

[52] U.S. Cl. **D14/102**

[58] Field of Search **D14/100-117;**
D13/162, 184, 199; 360/97.01-99.12;
361/390-395, 331, 380, 381; 200/5 A, 5 R, 6 A,
6 R; 312/208

FIG. 1 is a front elevational view of a computer housing showing our new design with replaceable panels being shown in broken lines for illustrative purposes only and forming no part of the claimed design; FIG. 2 is a rear elevational view thereof; FIG. 3 is a right side elevational view thereof; FIG. 4 is a left side elevational view thereof; FIG. 5 is a top plan view thereof; FIG. 6 is a bottom plan view thereof; FIG. 7 is a top, front, and left side perspective view thereof; and, FIG. 8 is a top, rear, and left side perspective view thereof.

[56] **References Cited**

U.S. PATENT DOCUMENTS

- D. 272,248 1/1984 Sanders et al. D14/109
- D. 288,094 2/1987 Davis et al. D14/100
- D. 294,261 2/1988 Alfonso D14/109 X
- D. 294,355 2/1988 Giannotti, Jr. et al. D14/102
- D. 298,752 11/1988 Hoshino D14/100

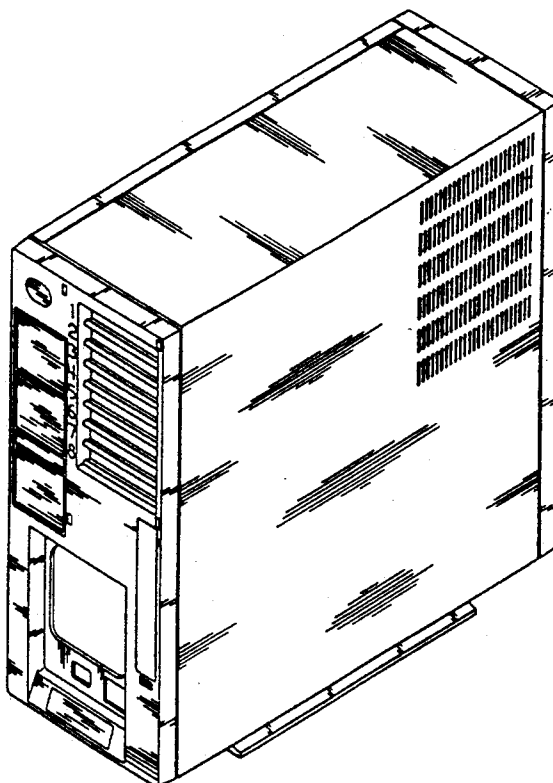
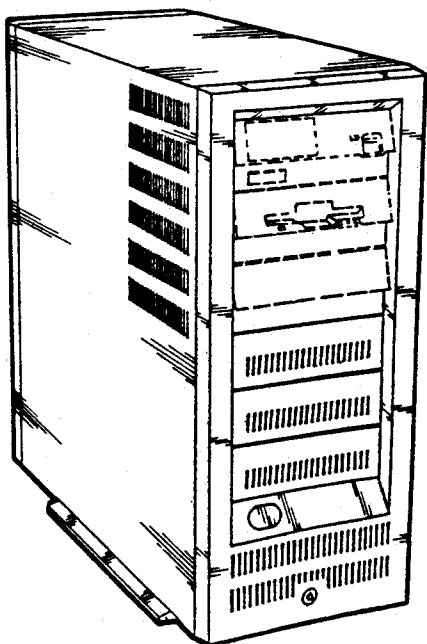

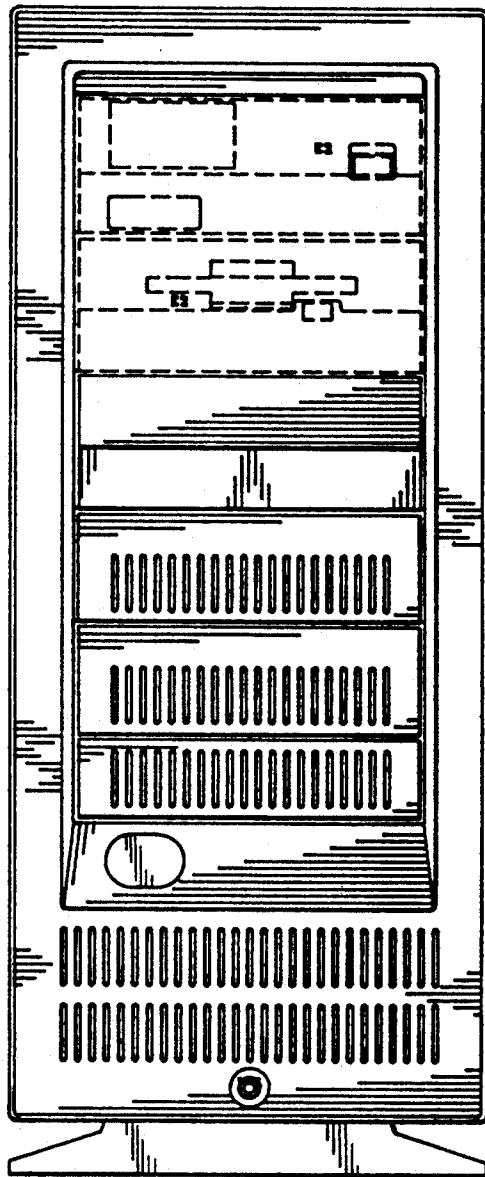

FIG. 1

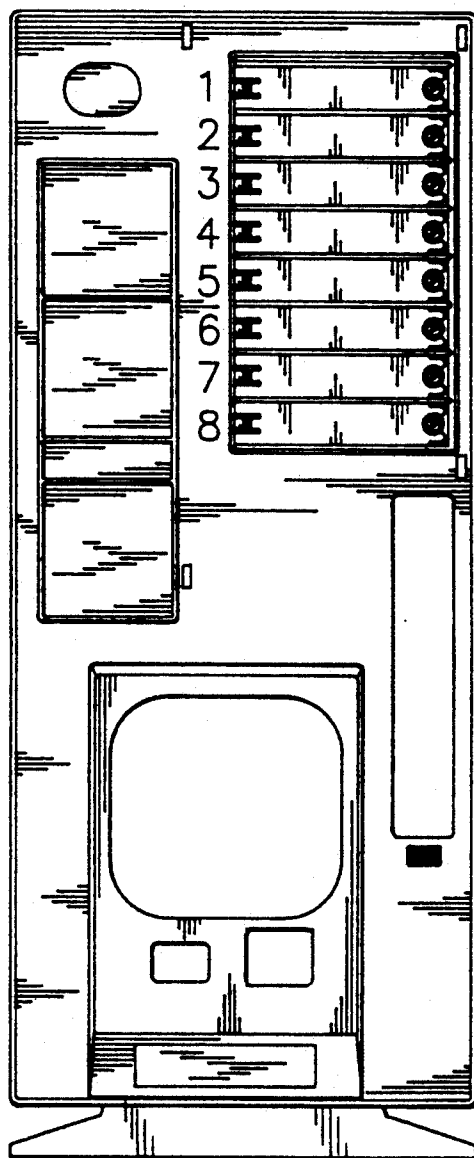

FIG. 2

FIG. 3

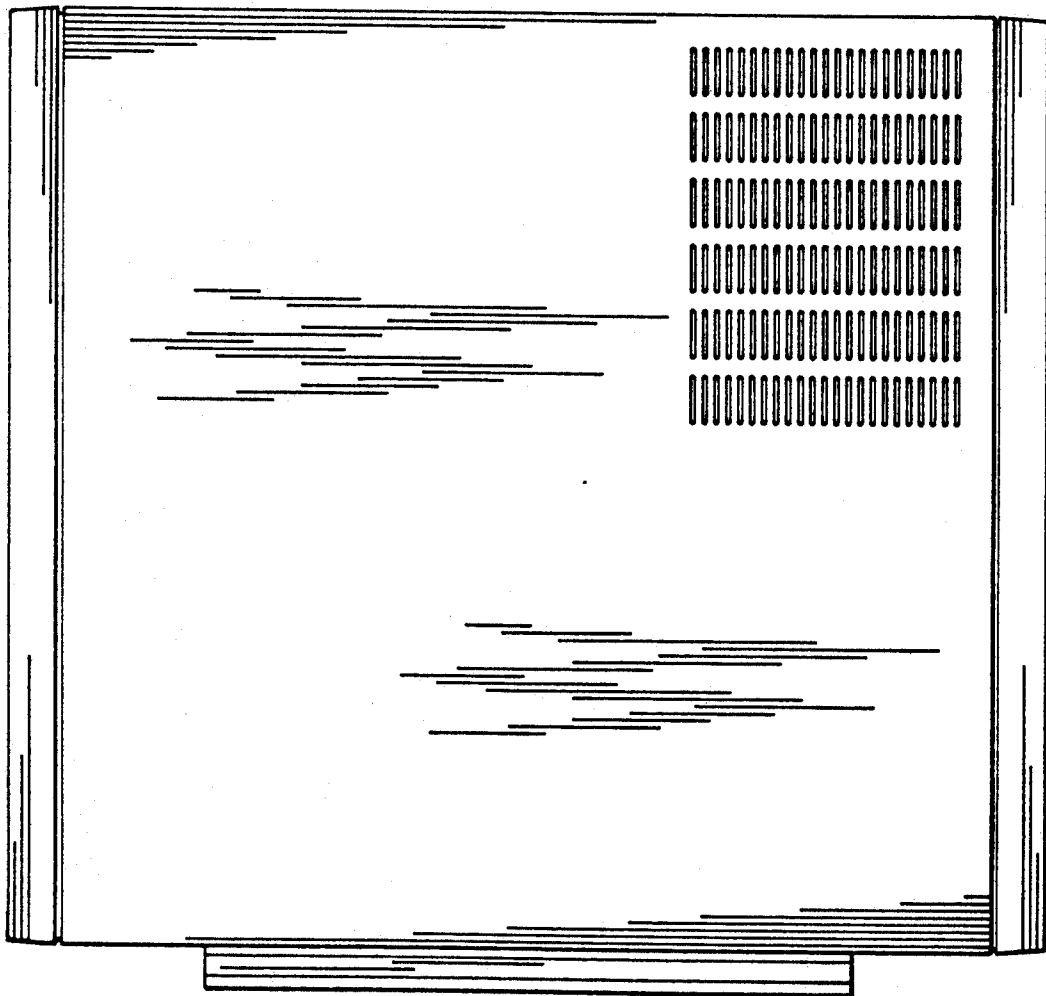

FIG. 4

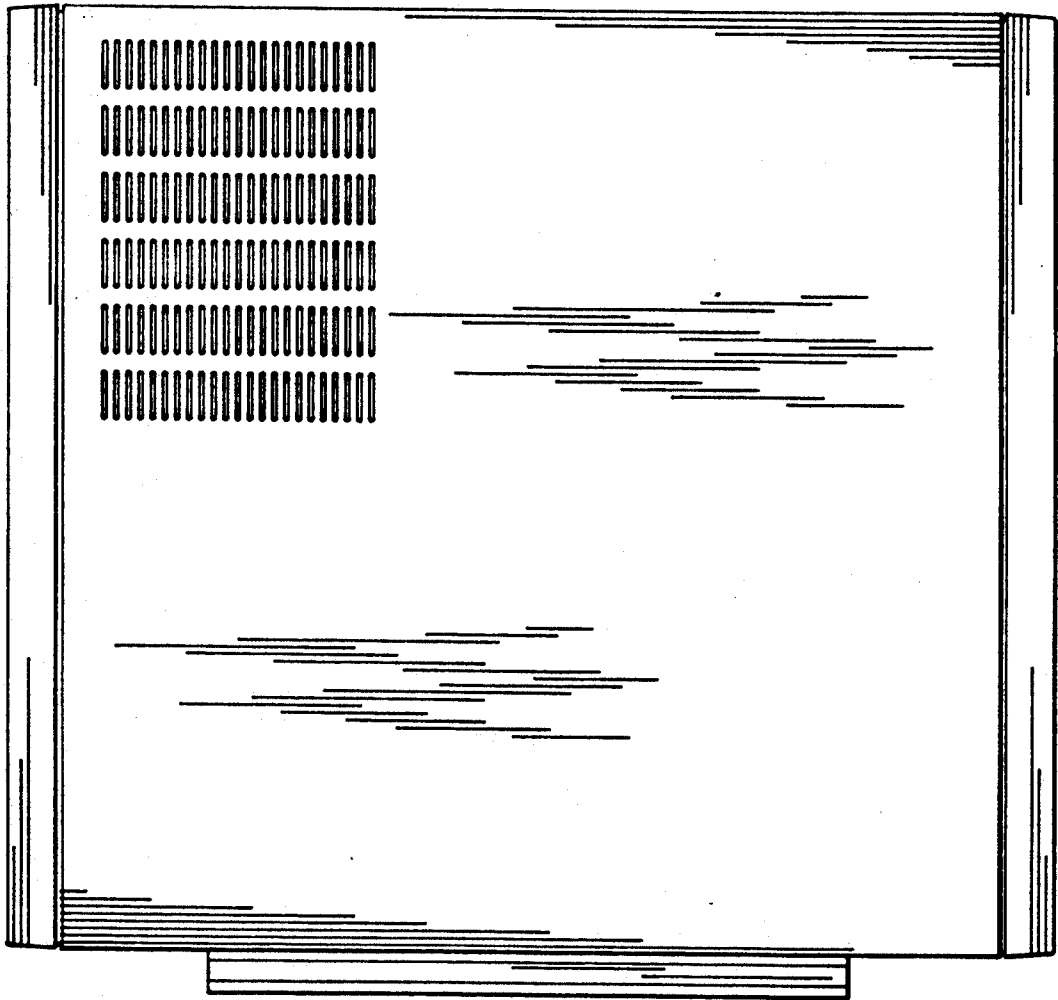

FIG. 5

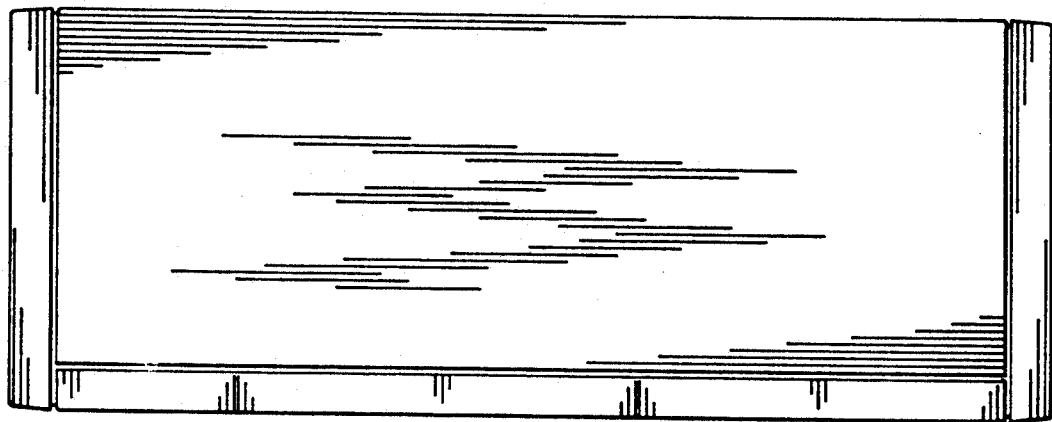
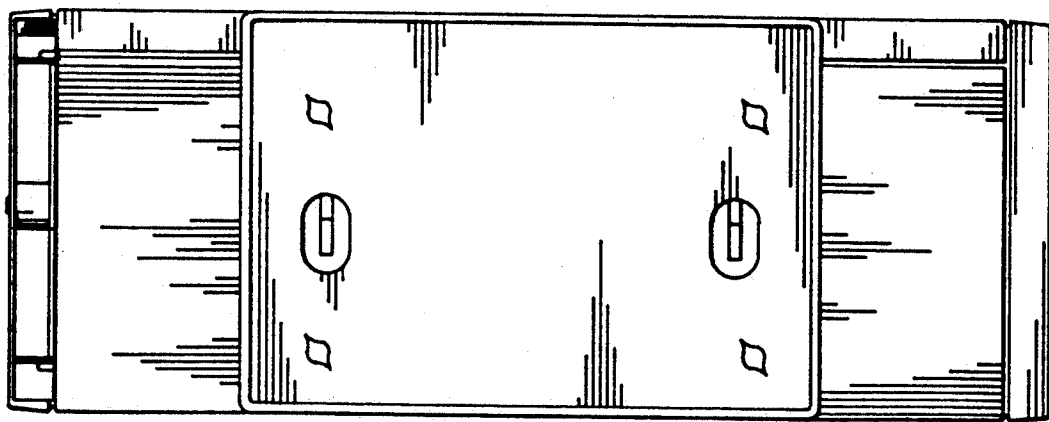

FIG. 6



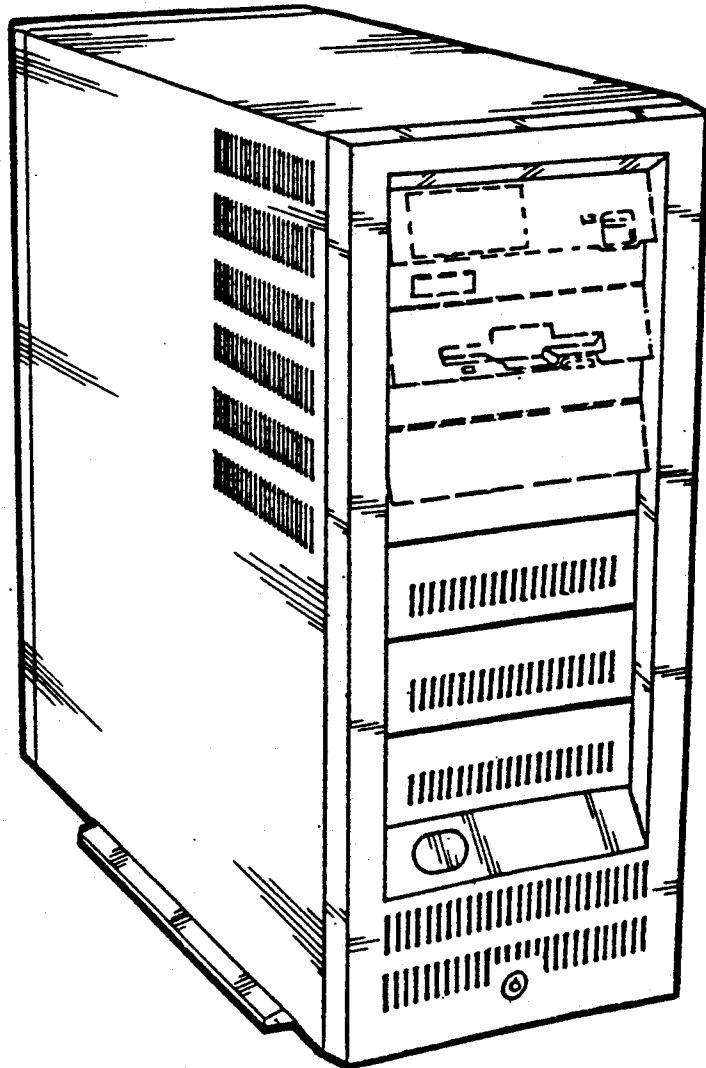

FIG. 7

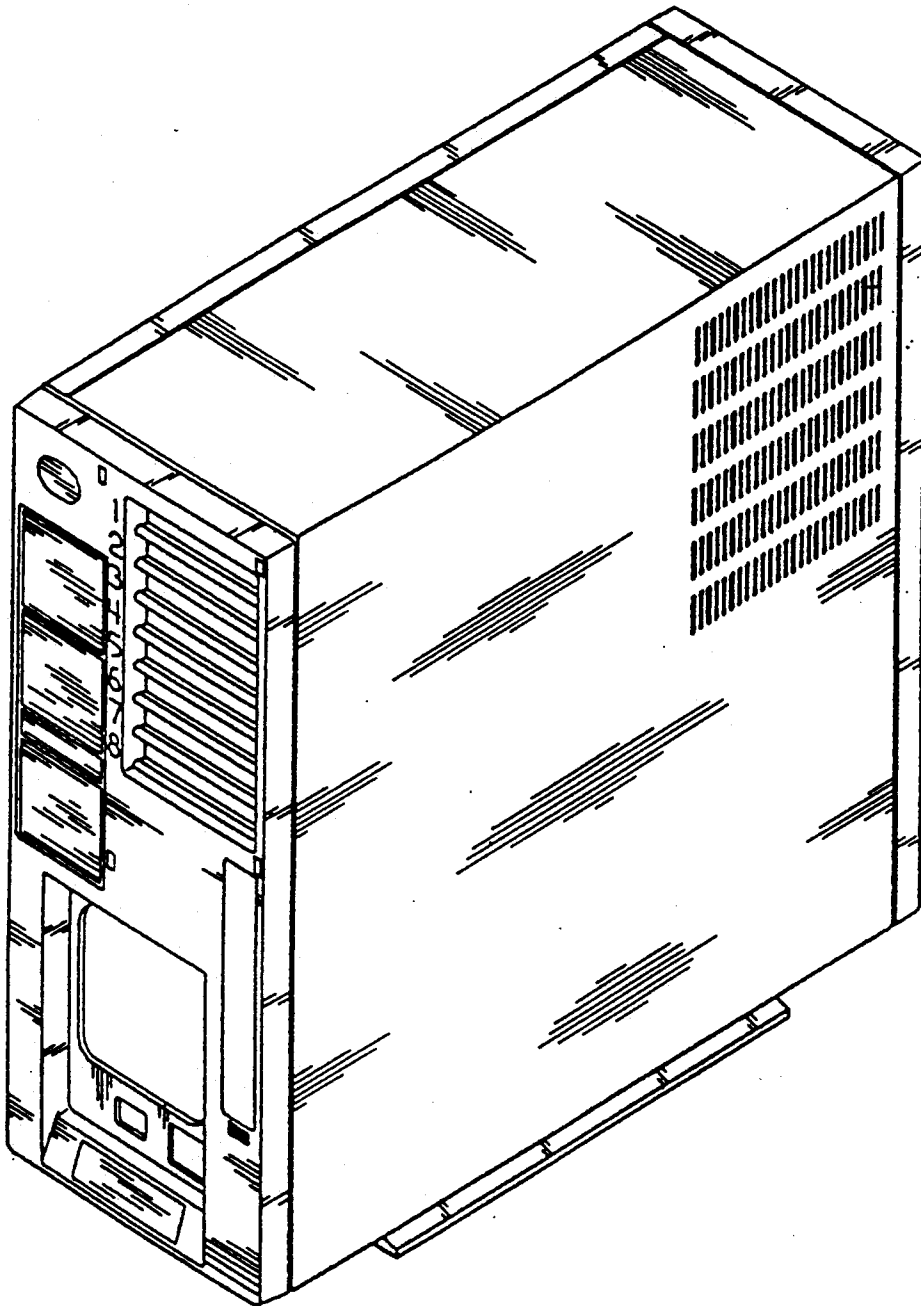

FIG. 8